

# CX<sup>3</sup> EMS

## ENERGY MANAGEMENT SYSTEM

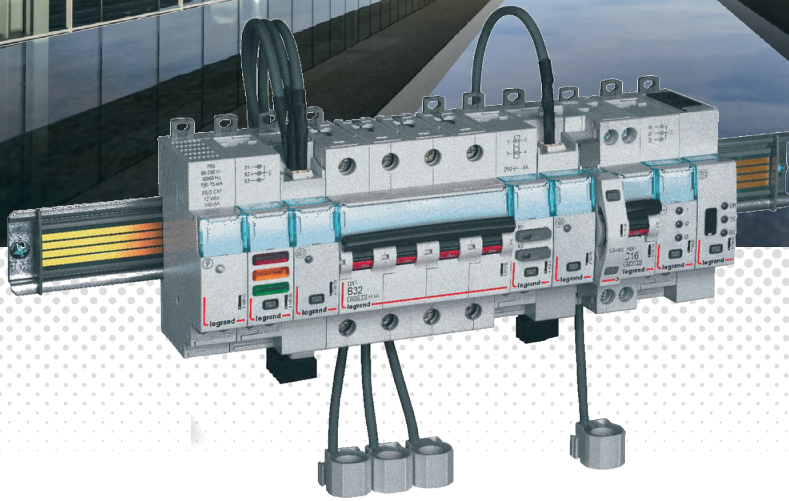

Legrand offers complete solutions to meet energy efficiency needs.

This technical guide provides all the essential information you need to know about **CX<sup>3</sup>EMS** in order to understand how to choose them, their characteristics, installation and configuration rules, etc ...

This document can be downloaded from the online catalog and is a complete technical guide on **CX<sup>3</sup>EMS** in the distribution board.

#### LEGAL INFORMATION

Presentation pictures do not always include Personal Protective Equipment (PPE), but this is a legal and regulatory obligation that must be scrupulously respected.

In accordance with its continuous improvement policy, Legrand reserves the right to change the specifications and illustrations without notice. All illustrations, descriptions and technical information included in this document are provided as indications and cannot be held against Legrand.

## TABLE OF CONTENTS

SAFETY INSTRUCTIONS .....	2
CX <sup>3</sup> EMS MEASUREMENT MODULES.....	6
CX <sup>3</sup> EMS PULSE CONCENTRATOR .....	20
CX <sup>3</sup> EMS UNIVERSAL SIGNALLING MODULE .....	24
CX <sup>3</sup> EMS AC + FC SIGNALLING AUXILIARY MODULE.....	32
CX <sup>3</sup> EMS UNIVERSAL CONTROL MODULE .....	38
CX <sup>3</sup> EMS CONTROL AND STATE REPORTING MODULE.....	46
CX <sup>3</sup> EMS POWER SUPPLY MODULE.....	54
CX <sup>3</sup> EMS ACCESSORIES AND CONNECTIONS .....	60
CX <sup>3</sup> EMS/RS485 INTERFACE .....	66
CX <sup>3</sup> EMS/DPX <sup>3</sup> INTERFACE .....	70
CX <sup>3</sup> EMS MINI-CONFIGURATOR.....	74
CX <sup>3</sup> EMS CONFIGURATION SOFTWARE.....	80

# SAFETY

# INSTRUCTIONS

## General information

- Use only the products and accessories recommended by the Legrand Group in the catalogue, instructions, technical data sheets and all other documents provided by Legrand (hereinafter referred to as «the Documentation») in compliance with the installation rules.
- Improper installation and/or use may result in the risk of arcing in the enclosure, overheating or fire. The enclosures must be used under normal conditions, they must not be subjected to Voltage / Current / Temperature values other than those specified in the Documentation.
- Legrand declines all responsibility for any modification or repair of the equipment making up the enclosure that is not authorized by the Legrand Group, as well as any failure to comply with the rules and recommendations specified by Legrand in the Documentation. In addition, in the cases mentioned above, the warranty granted by Legrand will not be applicable.
- It is necessary to check that the characteristics of the products are appropriate for their environment and use during maintenance operations, and to refer to the Documentation. If you have any questions or require clarification, please contact Legrand Group.
- The installation, use and maintenance of the enclosures and their components must be carried out by qualified, trained and authorized personnel, in accordance with the regulations in force in each country.



### **RISK OF ELECTRIC SHOCK, BURNS AND EXPLOSION.**

- People working on the installation must have the appropriate electrical authorizations for the work to be carried out.
- Wear the PPE (Personal Protective Equipment) necessary to work on live products.
- Respect the safety rules related to electrical work.
- Improper electrical and mechanical use of equipment can be dangerous and may result in personal injury or damage to property.
- Depending on the maintenance operations to be carried out, partial or total power cuts of the enclosure concerned should be planned before any work.
- When performing operations that involve access to the inside of the enclosure, be aware of the risk of burns before touching any products or metal parts.
- Before turning the power back on, make sure that there are no foreign bodies and that all physical protections have been put back in place (e.g.: screens, covers, shields).

Any failure to strictly apply the procedures and to respect these recommendations, could lead to serious risk of accident, endangering people and property (in particular, without limitation, risk of burns, electric shocks, etc.).



 The rules and recommendations in this document are based on our knowledge of the typical conditions of use of our products in the fields of application usually encountered. However, it is always the customer's responsibility to verify and validate that Legrand products are suitable for its installation and use.

The customer must ensure proper installation, maintenance and operation of the equipment to avoid any risk of injury to personnel or damage to property in the event of product failure, especially for applications that require a very high level of safety (e.g., those in which the failure of a component may endanger human life or health).

The rules for storage, handling, installation and maintenance and the appropriate precautions and warnings must be strictly observed and applied.

# CX<sup>3</sup> EMS

complete, compact  
and **multifunctional**



## MEASUREMENT



## SIGNALLING

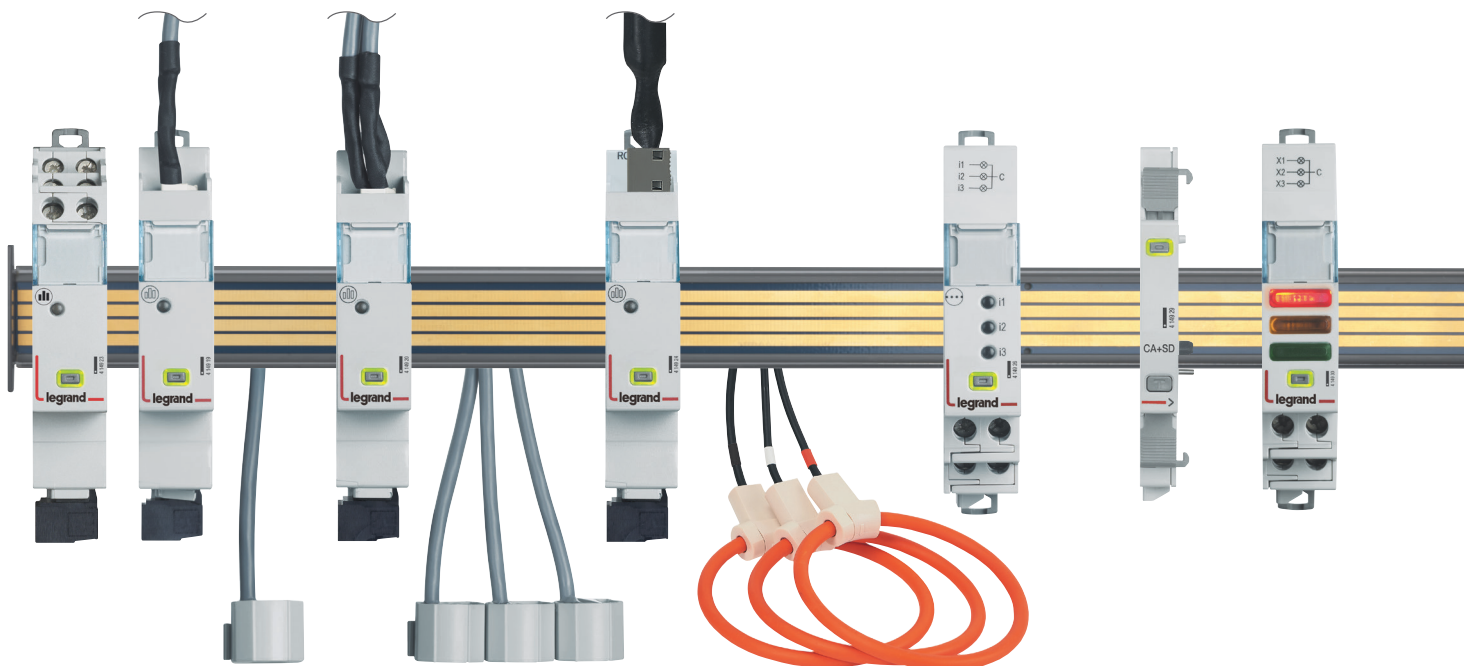

All the modules in the **CX<sup>3</sup> EMS supervision system** have compact dimensions, in order to minimise the space taken up in the electrical switchboard.

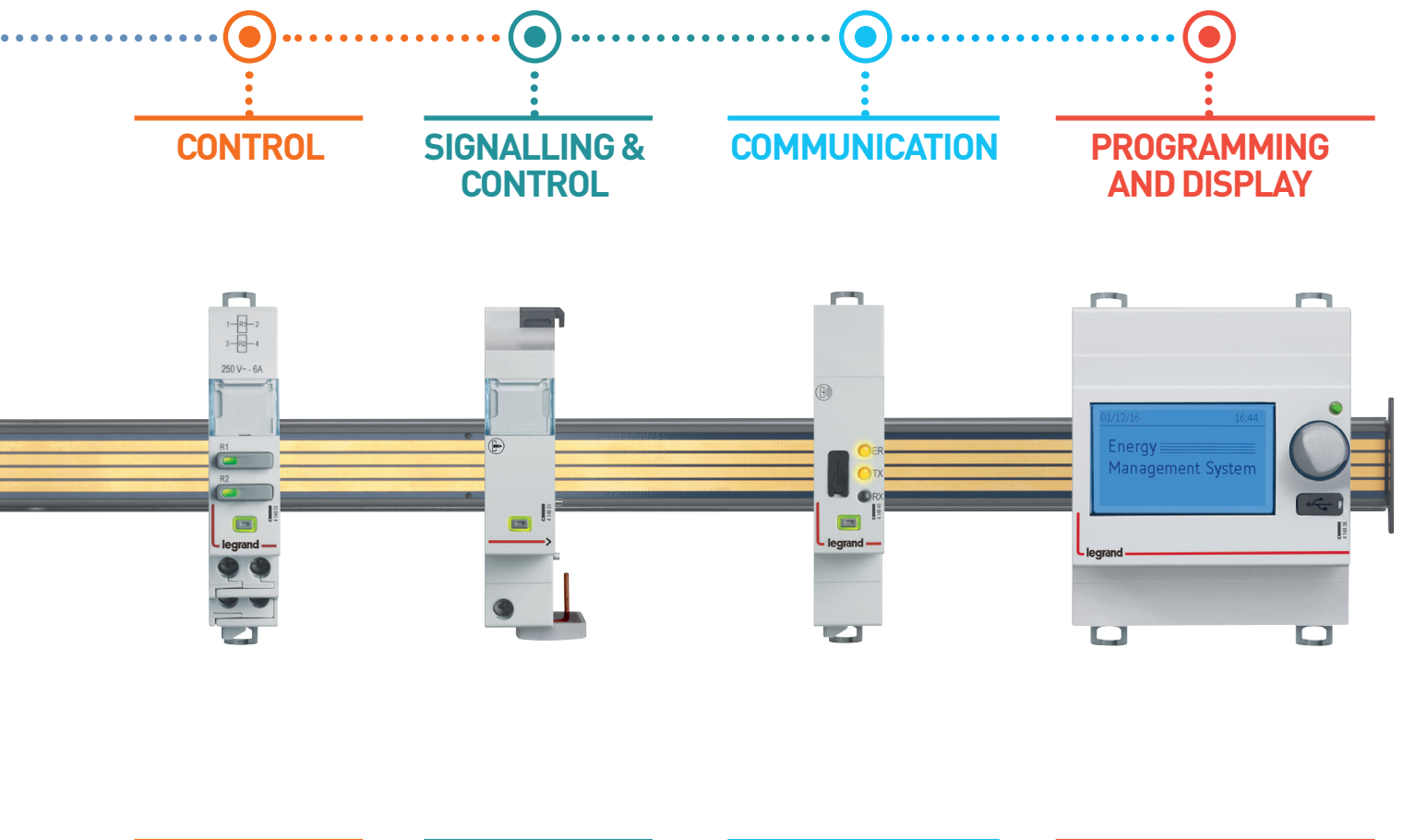

# CX<sup>3</sup> EMS MEASUREMENT MODULES

## Product specifications

Measurement modules are integrated in the EMS CX<sup>3</sup> system for monitoring energy in electrical panels.

Offering the same performance as conventional measurement control units, these record the electricity consumed by a single-phase or three-phase circuit and measure the electrical values (current, voltage, power, frequency, harmonics, etc).

There are 2 measurement module families:

- measurement up to 6300 A.
- high-current measurement with open Rogowski coil or with CT.

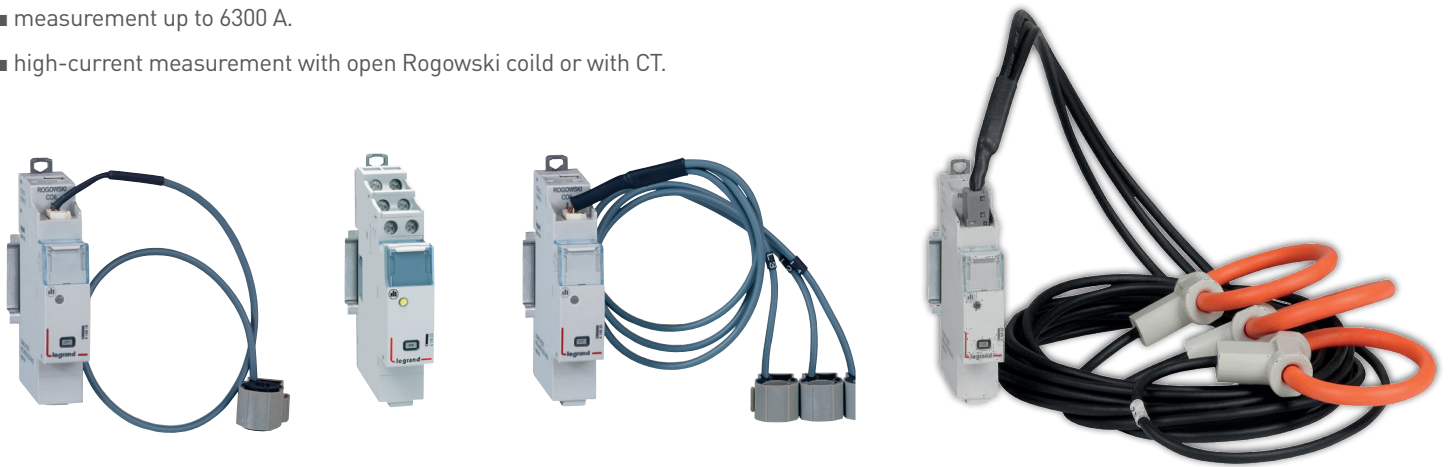



## CHARACTERISTICS

### ■ Display:

No display on the module itself, however data can be displayed locally (on mini-configurator Cat.No 4 149 36/37), or remotely (on a PC, tablet or smartphone screen).

### ■ Rated voltage Un:

Single-phase: 65 to 290 VAC  
Three-phase: 110 to 500 VAC

### ■ Consumption:

4 149 19: 34,1 mA - 0,410 W  
4 149 20: 34,8 mA - 0,419 W  
4 149 23: 32,6 mA - 0,391 W  
4 149 18: 34.8mA - 0.418 W  
4 149 21: 34.8mA - 0.418 W  
4 149 22: 34.8mA - 0.418 W  
4 149 24: 34.8mA - 0.418 W  
4 149 25: 34.8mA - 0.418 W

### ■ Supply voltage:

12 VDC via CX3 EMS power supply module Cat.No: 4 149 45.

### ■ Frequency: 50 – 60 Hz

### ■ Conforming to standards:

IEC / EN 61557-12  
IEC/EN 61131-2  
(PLC)

### ■ Accuracy:

Active energy  
(IEC / EN 61557-12): class 0.5  
Reactive energy  
(IEC / EN 61557-12): class 1

### ■ Connection with CT:

Supplied for Cat.Nos 4 149 18 / 19 / 20 / 21 / 22 / 24 / 25 / 27.  
Not supplied for Cat.No 4 419 23.

### ■ Output:

Via communication rail or cable on the EMS CX<sup>3</sup> bus. Modbus RS485 output option via interface Cat.No 4 149 40.

### ■ Mounting: on DIN rail.

### ■ Dimensions: width 1 module.

## PRODUCT SELECTION

The measurement module should be chosen according to the supply (single-phase or three phase), its maximum current and, from the current transformer type.

		 4 149 18	 4 149 19	 4 149 20	 4 149 21
Supply type	Single-phase	OK (3 x single-phase)	OK	/	/
	Three-phase	/	/	OK	OK
Number of modules		1	1	1	1
Connection	Direct (max.current)	Up to 63 A	Up to 63 A	Up to 63 A	Up to 125 A
	Via a current transformer	/	/	/	/
Metering and measurement	Total active energy	OK	OK	OK	OK
	Total reactive energy	OK	OK	OK	OK
	Partial active energy (reset)	OK	OK	OK	OK
	Partial reactive energy [reset]	OK	OK	OK	OK
	Active power	OK	OK	OK	OK
	Reactive power	OK	OK	OK	OK
	Apparent power	OK	OK	OK	OK
	Current + voltage	OK	OK	OK	OK
	Frequency	OK	OK	OK	OK
	Power factor	OK	OK	OK	OK
	THD phase-to-neutral voltages	OK	OK	OK	OK
	THD phase-to-phase voltages	OK	OK	OK	OK
	THD currents	OK	OK	OK	OK
THD Odd-order harmonics	Up to 15th order	Up to 15th order	Up to 15th order	Up to 15th order	
Communication	CX <sup>3</sup> EMS protocol	OK	OK	OK	OK
Load shedding	Load shedding according to a measurement threshold that has been reached	OK	OK	OK	OK

					
	4 149 22	4 149 24	4 149 25	4 149 27	4 149 23
	/	/	/	/	OK
	OK	OK	OK	OK	OK
	1	1	1	1	1
	Up to 750 A	Up to 1950 A	Up to 3900 A	Up to 7500 A	/
	/	/	/	/	5 A at the secondary
	OK	OK	OK	OK	OK
	OK	OK	OK	OK	OK
	OK	OK	OK	OK	OK
	OK	OK	OK	OK	OK
	OK	OK	OK	OK	OK
	OK	OK	OK	OK	OK
	OK	OK	OK	OK	OK
	OK	OK	OK	OK	OK
	OK	OK	OK	OK	OK
	OK	OK	OK	OK	OK
	OK	OK	OK	OK	OK
	OK	OK	OK	OK	OK
	OK	OK	OK	OK	OK
	OK	OK	OK	OK	OK
	OK	OK	OK	OK	OK
	Up to 15th order	Up to 15th order	Up to 15th order	Up to 15th order	Up to 15th order
	OK	OK	OK	OK	OK
	OK	OK	OK	OK	OK

**VIEWING DATA**

To minimise the dimensions, measurement modules do not have a data display. Nonetheless various display modes are possible:

Locally, int the enclosure, on mini-configurator,  
Cat.No 4 149 36 :

Remotely, on a PC, tablet or smartphone screen. The CX<sup>3</sup> EMS / RS485 / IP interfaces Cat.No 4 149 40 and 0 046 89 must be used to access devices such as the touch screen, the Energy Management software Cat.No 4 149 38/39 and the Energy Web Server Cat.No 4 149 47/48/49.

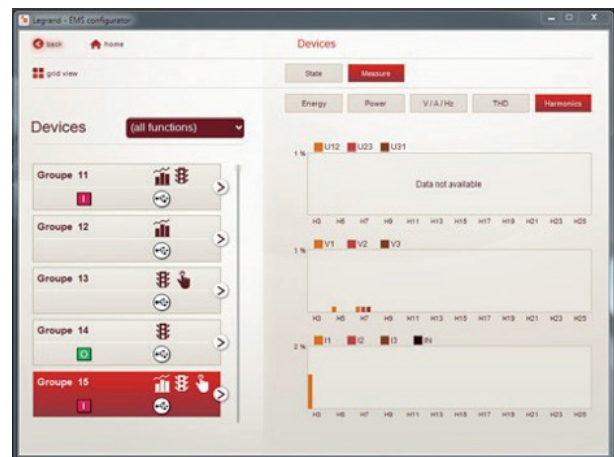
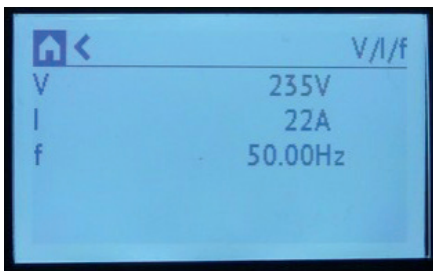
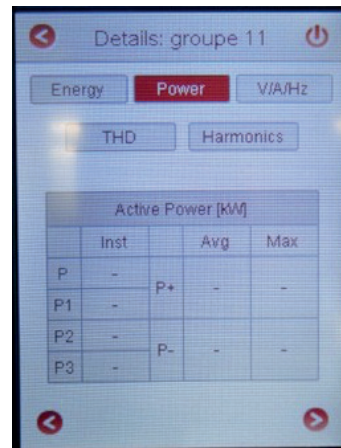
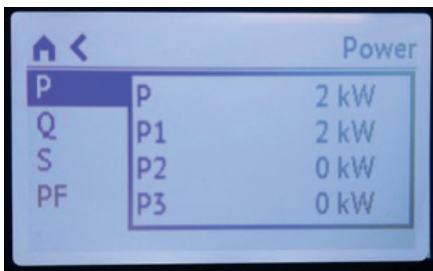

## WIRING

Measurement modules have 2 types of input: "current" and "voltage" inputs. Each current transformer secondary is connected to the corresponding inputs and thus allows the current flowing through the CT to be measured. To measure the voltage, each conductor is connected to the respective voltage tap terminals.

### ■ Current measurement for measurement modules to be connected by closed Rogowski coil up to 125 A:

3 measurement modules are available for measurement up to 63 A and 1 Cat.No up to 125 A.

They are supplied with closed Rogowski coil(s) for single-phase or three-phase measurement.

Cat. No 4 149 18 for 3 single-phase measurement:

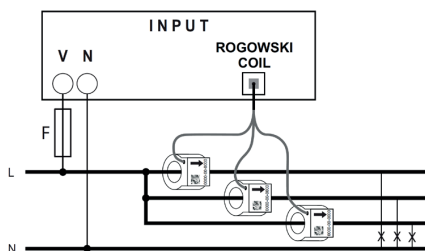

Cat.No 4 149 19 for a single phase measurement:

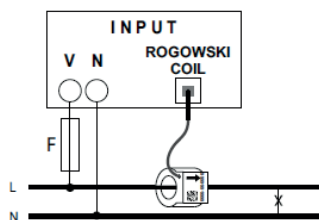

Cat.No 4 149 20 (63 A) / 4 149 21 (125 A) for a three-phase measurement:

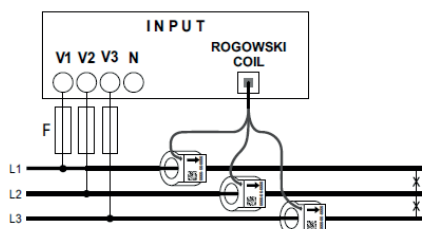
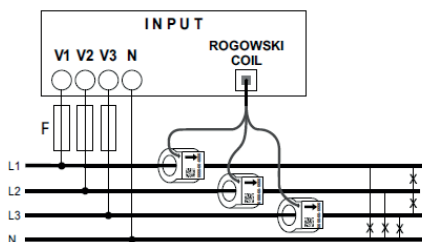

Each coil is supplied with a flexible internal guide which ensures the cable is centered in the coil. Depending on the cable cross-section, the guide can be removed or retained.

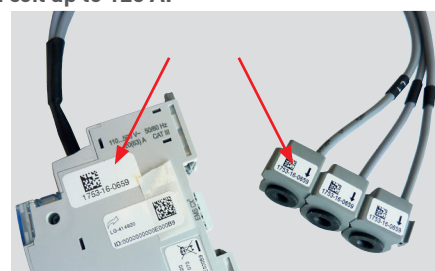

**!** The coil(s) on a measurement module can be disconnected. The coils are calibrated in the factory for use in conjunction with the measurement modules.

If several modules are used in the same installation, it is important to check, before mounting, that the serial numbers are identical on the coil and module identification labels.

The coils can be separated for better integration in existing installations.

The coils are marked L1 . L2 . L3. Wiring must be done in this order, for the data to be displayed correctly.



## WIRING (CONTINUED)

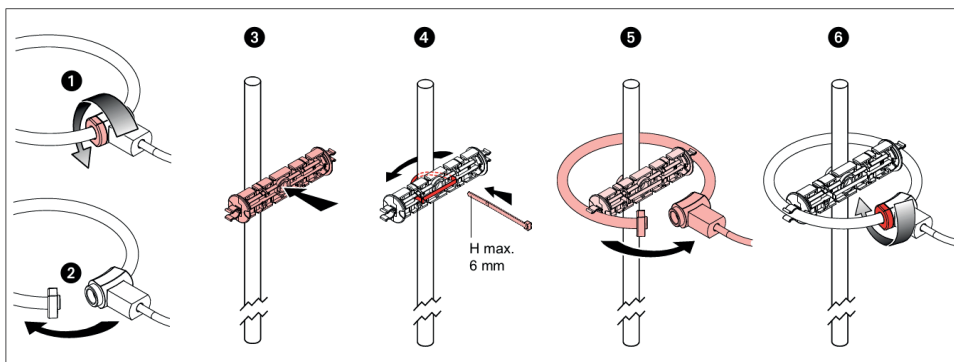

### ■ 63 A 3 x Single:



Cat.No 4 149 18

### ■ 63 A Three:



Cat.No 4 149 20

### ■ 63 A 3 x Single:



Cat.No 4 149 19

### ■ 125 A Three:



Cat.No 4 149 21

## WIRING (CONTINUED)

### ■ Current measurement for measurement modules to be connected by current transformer for high current measurement:

One measurement module is available for high current measurement. It is supplied without a CT and can be wired to any type of ferromagnetic coil, open or closed, 5 A at the secondary.

This measurement module Cat.No 4 149 23 provides the option of measuring a single-phase or three-phase supply.

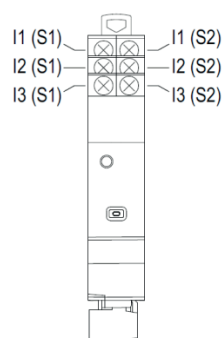

### HIGH CURRENT MEASUREMENT

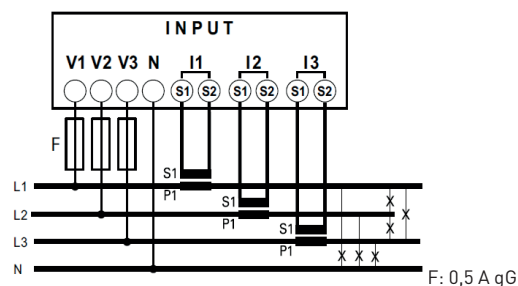
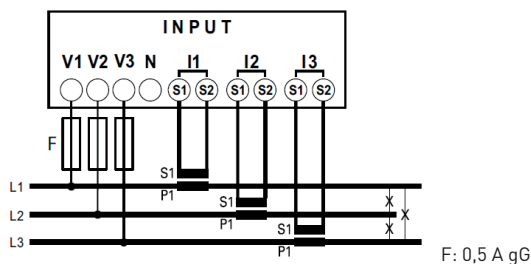
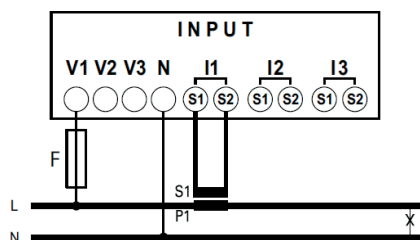

### ■ Current measurement for measurement modules to be connected by open Rogowski coils:

4 Modules dedicated to EMS CX<sup>3</sup> (Energy Management System) Multifunction measurement modules for high currents that allow to measure the main electrical data of a three-phase circuit.

#### ■ Measurement via open, flexible Rogowski coils:

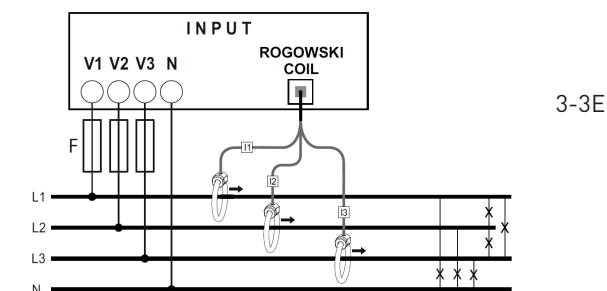
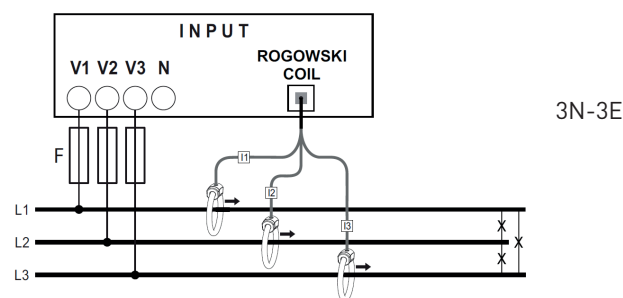

How to determine the maximum possible length between the CTs and the measurement module is explained in the "Current transformers" technical guide.

## WIRING (CONTINUED)

### ■ 630 A, 1600 A, 3200 A et 6300 A:



Cat.No 4 149 22



Cat.No 4 149 24



Cat.No 4 149 25



Cat.No 4 149 27

Measure with open flexible Rogowski coils. High performance: measurement modules up to 6300 A ( $I_{max} = 7500$  A). The range of CX<sup>3</sup> EMS measurement modules, now allows to measure high currents :  $I_{base} = 630$  A ( $I_{max} = 750$  A),  $I_{base} = 1600$  A ( $I_{max} = 1950$  A),  $I_{base} = 3200$  A ( $I_{max} = 3900$  A) et  $I_{base} = 6300$  A ( $I_{max} = 7500$  A).

#### Open flexible coils:

Adjust the busbars perfectly in all positions (horizontal, vertical). Ultra compact Rogowski. Coils always centered thanks to a plastic support.

#### Always compact:

Associated measurement module only on 1 module wide.

#### Suitable for all installations:

Set up installations with limited space in small areas. Can be adapted to the busbar in any position. 1 wide measuring module to provide complete data: current, active/reactive power,  $\cos \phi$ , harmonics...

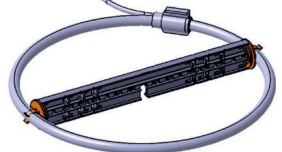
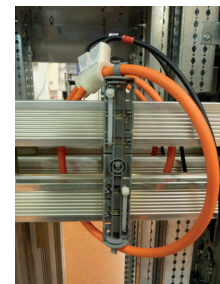

Each coil receives a plastic support perfectly centered along the busbar.



## WIRING (CONTINUED)

Lateral rotating clip for easy integration of the support in any position.

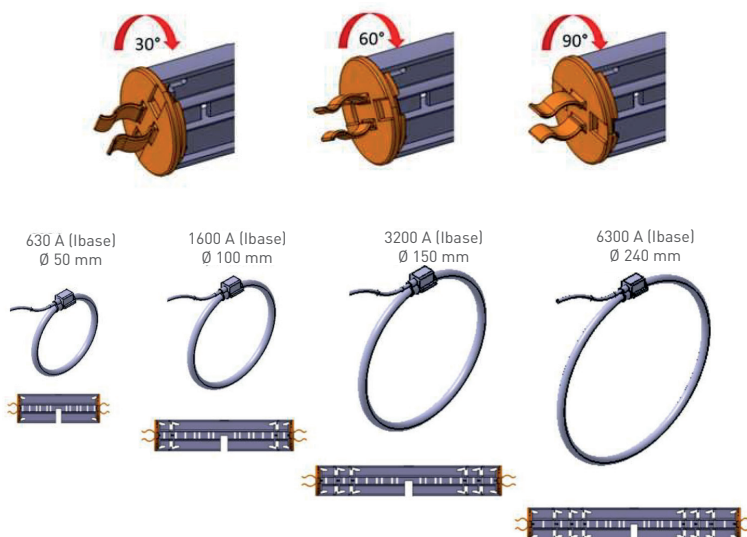

## WIRING (CONTINUED)

### ■ Voltage measurement:

The voltage is measured in the same way as on all measurement module catalogue numbers.

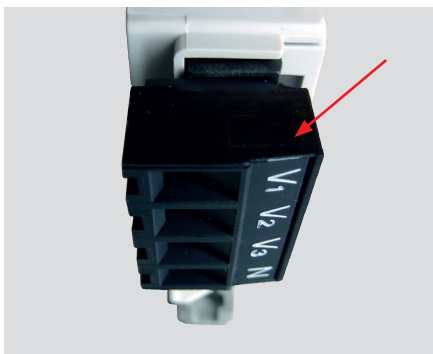

**i** To protect the measurement control units, refer to the information in the product manuals and technical data sheets.

**i** It is possible to make a single voltage tap for several modules, make sure that:

- the voltage source is identical for all measuring points;
- a jumper must be installed between the modules, respecting the phase sequence;
- a protection must be set up for all the «voltage measurements» of the concerned measurement modules;
- this protection must be x times amperage of a module (x being the number of measurement modules).

### ■ CX<sup>3</sup> EMS bus:

There are 2 possible solutions for connection to the bus:



At the back of the modules via communication rail Cat.Nos 4 149 01/02/03



At the bottom of the modules via communication cables Cat.Nos 4 149 07/08/09

**i** The CX<sup>3</sup> EMS bus connection specifications are common to all CX<sup>3</sup> EMS products and are detailed in the product data sheets.

### RAIL CONNECTION

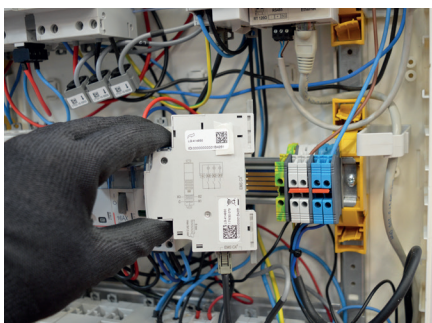

### CABLE CONNECTION

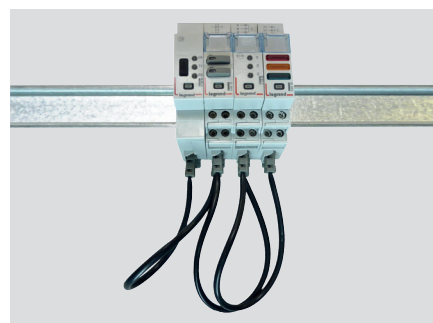

## WIRING (CONTINUED)

### ■ Integration in optimised distribution system:

The upper side terminals of the measurement modules Cat.Nos 4 419 19 and 4 419 20 have been designed to allow single-phase and three-phase supply busbars to pass freely. Therefore, the modules can integrate HX<sup>3</sup> optimised distribution system; making it possible to have a combination of functions in the same DIN rail. The energy management modules are then as close as possible to the protection modules.

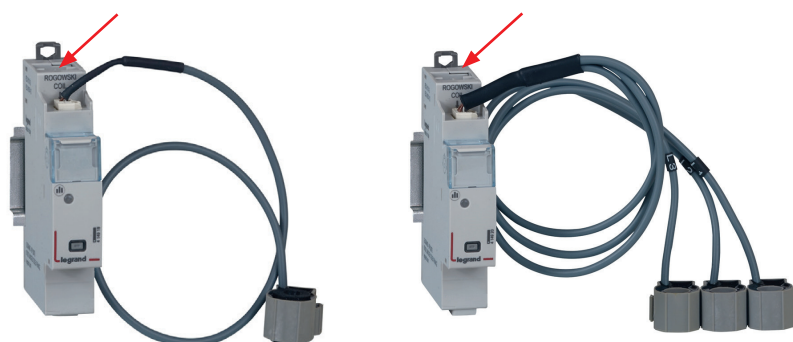

### OPTIMISED DISTRIBUTION POSSIBLE



## SETTING PARAMETERS

The parameters of the measurement module can be set as follows:

-Remotely: via the CX<sup>3</sup> EMS configuration software.

-Locally: on th mini-configurator Cat.No 4 149 36.

### ■ Possible Setting parameters depending on the measurement modules:

#### - Single-phase measurement module Cat.No 4 149 19:

If the current has been wired in the wrong direction in the Rogowski coil, it is possible to change it, simply by modifying the settings.

Setting parameters on the mini- configurator:

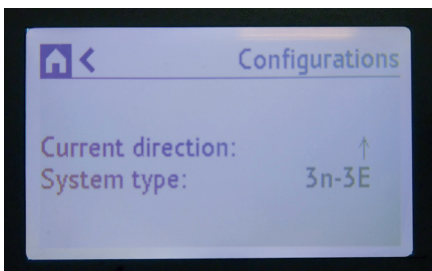

**i** This function avoids having to modify the wiring in case of an error.

**i** The configuration software can be downloaded free of charge from the online catalogue.

#### - Three-phase measurement module Cat.No 4 149 20:

Like the single-phase measurement module, it is possible to change the current direction in the Rogowski coil, simply by modifying the settings.

The three-phase measurement module can be used in three-phase or three- phase + neutral circuits.

Setting parameters on the mini- configurator:

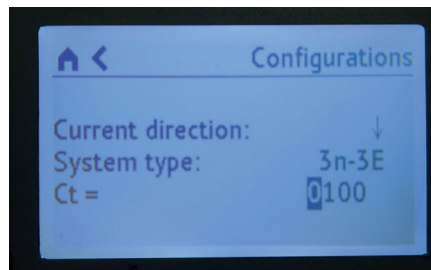

**i** Setting parameters is identical and easily done on both devices.

#### - High current measurement module Cat.No 4 149 23:

Like the previous measurement modules, it is possible to change the current direction in the CT, simply by modifying the settings.

The high-current measurement module can be used in single-phase, three- phase or three-phase + neutral circuits.

The last parameter that can be modified is the result obtained by dividing the primary current and the secondary current (5 A) of the associated current transformer(s).

Setting parameters on the EMS configuration software:

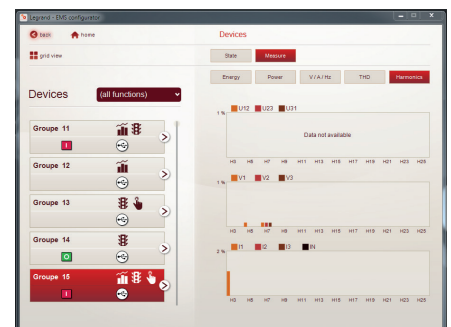
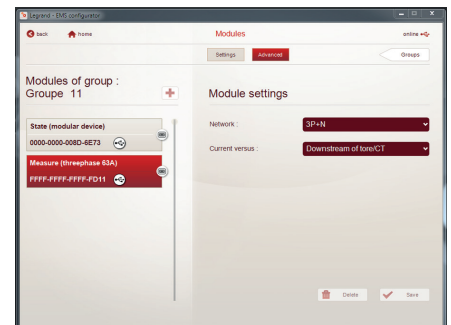

## SETTING PARAMETERES (CONTINUED)

### - Single-phase measurement module Cat.No 4 149 18:

In the event of an error in the wiring of the direction of the current in the Rogowski coil, it can be modified, by intervening only on the parameters.

Setting parameters on the mini-configurator:

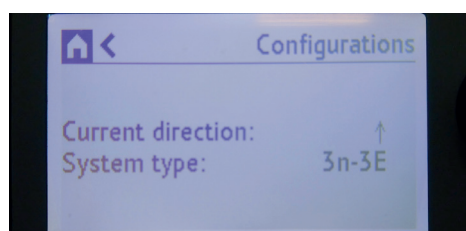

### - Three-phase measurement module Cat.No 4 149 22:

In the event of an error in the wiring of the direction of the current in the Rogowski coil, it can be modified, by intervening only on the parameters.

Setting parameters on the mini-configurator:

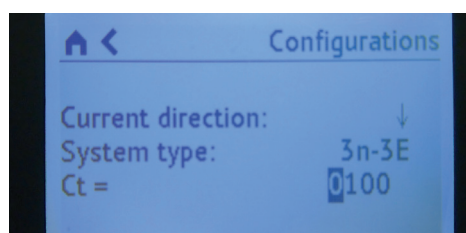

## DATA TRANSFER

The measurement modules transfer information directly over the CX<sup>3</sup> EMS bus and can thus be used to transfer data to an operating system.

As previously seen ("Viewing data" section), the information is available on the mini-configurator, the touch screen, the measurement software and the Energy Web Server.

The Modbus register tables are made available for use by a systemsintegrator.

In this case, an CX<sup>3</sup> EMS/RS485 Modbus interface is needed.

**i** The load-shedding function is possible with the integration of the universal control module Cat.No 4 419 32. Details and examples can be found in the section «CX<sup>3</sup> EMS Configuration Software» on page 80.

## ADDRESSING

Addressing can be done:

- Locally on the product
  - addressing from 1 to 9 using a selector.
- Via software
  - addressing from 1 to 247
  - the selector then stays on 0.



**i** The specifications for connection to the CX<sup>3</sup> EMS bus are common to all CX<sup>3</sup> EMS devices and are described in the product technical data sheets.

**!** Local setting using the selector takes priority over software Setting parameters. In the event of malfunction, check that the selector is definitely on zero.

# CX<sup>3</sup> EMS PULSE CONCENTRATOR

## Product specifications

Pulse concentrator module  
Cat.No 4 149 26 is integrated in the  
CX<sup>3</sup> EMS system for monitoring  
energy in electrical panels.

It collects pulses emitted by electricity,  
gas, water, oil meters, etc and  
transmits this information over the  
CX<sup>3</sup> EMS bus to an operating system.



### CHARACTERISTICS

- **Display:**  
No display on the module itself, data can be displayed locally (on mini-configurator Cat.No 4 149 36), or remotely (on a PC, tablet or smartphone screen).
- **Supply voltage:**  
12 VDC via CX<sup>3</sup> EMS power supply module Cat.No 4 149 45.
- **Consumption:** 24 mA - 0.288 W
- **Conforming to standards:**  
IEC/EN 61131-2 (PLC)
- **Outlet:**  
Via communication rail or cable on the CX<sup>3</sup> EMS bus. RS485 Modbus output option via interface Cat.No 4 149 40.
- **Connection:**  
3 digital inputs with NO volt-freecontact.
- **Mounting:** DIN rail.
- **Dimensions (width):** 1 module.

## PRODUCT SELECTION

Pulse concentrator module Cat.No 4 149 26 is used to:

- Display, at a single point, the consumption values on up to 3 pulse meters (electricity, gas, water, etc).
- Transmit this information over the CX<sup>3</sup> EMS bus so it can be processed by an energy management system.

## VIEWING DATA

To minimise the dimensions, measurement modules do not have a data display. Nonetheless various display modes are possible:

Locally, in the enclosure, on mini-configurator Cat.No 4 149 36:

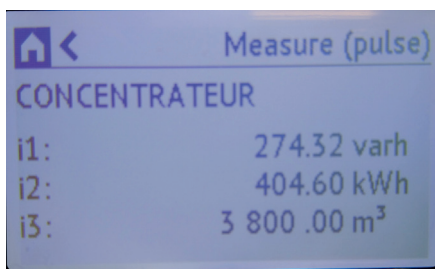

Remotely, on a PC, a tablet, a smartphone. The CX<sup>3</sup> EMS / RS485 / IP interfaces should be used to access devices such as the touch screen Cat.No. 0 261 56, the Energy Management Software Cat.No. 4 149 38/39 and the Energy Web Servers Cat.No. 4 149 47/48/49.

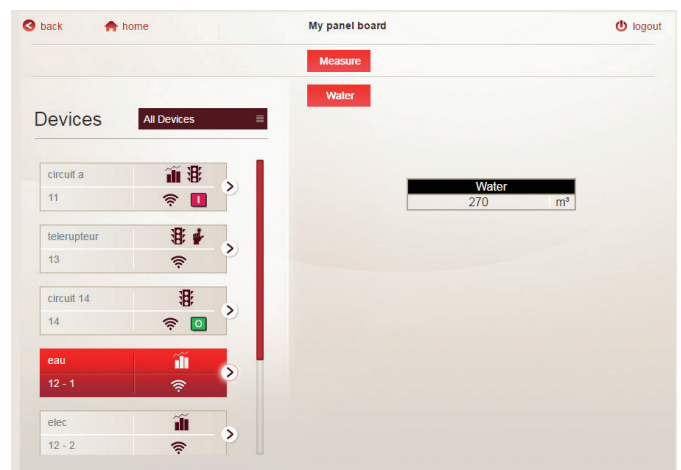

**WIRING**

■ **Meters on the concentrator module:**

Each pulse meter output is connected on the meter side to one of the 3 concentrator inputs. The common of these outputs should be connected to a single terminal.

**i** Length of cable between each meter and the concentrator: max 1000 m - circuit resistance less or equal to 125 Ohms or less at 25°C.

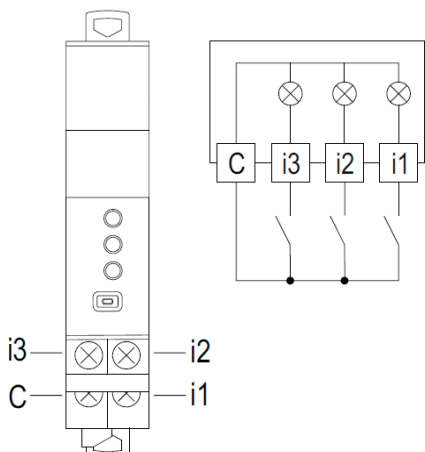

**i** Ensure correct polarity of the pulse outputs on the meters connected to the module.

■ **CX<sup>3</sup> EMS bus:**

There are 2 possible solutions for connection to the bus:



At the back of the modules via communication rail  
Cat.Nos  
4 149 01/02/03



Downstream of the modules via communicating cables  
Cat.Nos  
4 149 07/08/09

**i** The specifications for connection to the CX<sup>3</sup> EMS bus are common to all CX<sup>3</sup> EMS devices and are described in the product technical data sheets.

■ **Integration in optimised distribution system:**

The pulse concentrator module allows the supply busbar to pass freely. Therefore, the module can integrate HX<sup>3</sup> optimised distribution system without modifying the parity of the teeth.





### SETTING PARAMETERS

To minimise the dimensions of the product, the pulse concentrator module parameters can only be set with the help of:

- the CX<sup>3</sup> EMS configuration software
- or
- the mini-configurator Cat.No 4 149 36.

#### ■ Possible settings for the pulse concentrator module:

For each of the 3 pulse inputs, the pulse weight can be modified as well as the measurement unit of.

Setting parameters on the mini-configurator:

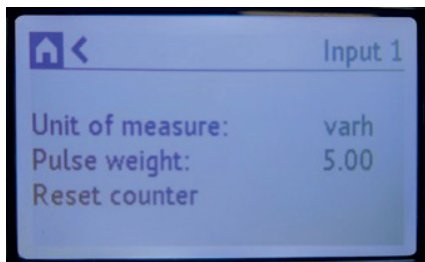

Setting parameters on the CX<sup>3</sup> EMS configuration software:

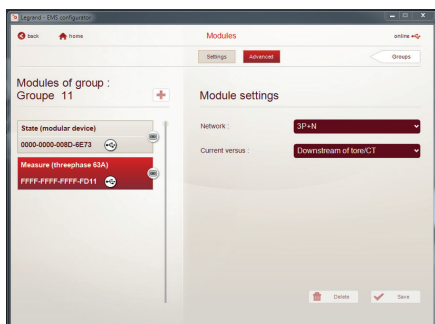

**i** Setting parameters is identical and easily done using either method.

### DATA TRANSFER

The measurement module sends the information back directly to the CX<sup>3</sup> EMS bus, allowing the data to be fed back to an operating system.

As seen on page 21 (section «Viewing data»), the information is available on the mini configurator Cat.No 4 149 36, the touch screen Cat.No 026156, the Energy Management Software Cat.No 4 149 38/39 and the Energy Web Servers Cat.No 4 149 47/48/49.

The Modbus register table is available for use by a system integrator. In this case, an CX<sup>3</sup> EMS / RS485 Modbus interface is required.

### MODBUS ADDRESSING

Addressing can be done:

- Locally on the product
  - addressing from 1 to 9 using a selector.
- Via software
  - addressing from 1 to 247,
  - the selector then stays on 0.



**i** The specifications for connection to the CX<sup>3</sup> EMS bus are common to all CX<sup>3</sup> EMS devices and are described in the product technical data sheets.

**!** Local setting using the selector takes priority over software Setting parameters. In the event of malfunction, check that the selector is definitely on zero.

# CX<sup>3</sup> EMS UNIVERSAL SIGNALLING MODULE

## Product specifications

Universal signalling module  
Cat.No 4 149 30 is integrated in the  
CX<sup>3</sup> EMS system for monitoring  
energy in electrical panels.

Information such as “on/off/fault”,  
“plugged-in/drawn-out”, etc are signalled  
by 3 LEDs directly on the module and  
sent remotely over the CX<sup>3</sup> EMS bus.

The information type parameters can be  
set by microswitches directly on the device.



### CHARACTERISTICS

- **Display:**  
Via 3 LEDs on the front of the module.  
Data can be displayed locally (on mini-  
configurator  
Cat. No 4 149 36), or remotely (on a  
PC, tablet or smartphone screen).
- **Supply voltage:**  
12 VDC via CX<sup>3</sup> EMS power supply  
module Cat. No 4 149 45.
- **Control:**  
Via volt-free contacts.
- **Maximum consumption:**  
31.4 mA - 0.377 W
- **Conforming to standards:**  
IEC/EN 61131-2 (PLC)
- **Connection:**
  - power supply via communication  
rail or cables on the CX<sup>3</sup> EMS bus
  - control via screw terminals.
- **Mounting:** DIN rail.
- **Dimensions (width):** 1 module.



Details and examples can be found in «CX<sup>3</sup> EMS Configuration Software» on page 80.

## PRODUCT SELECTION

Only one catalogue number to remember: 4 149 30. The various information type parameters are set by 4 microswitches on the side of the module and/or by software programming.

MICROSWITCH POSITION				DETAILS	
	X 1	X 2	X 3		
				<b>Software programming</b> —default configuration In this case, information from the 3 inputs is generic: "active" or "inactive" input For the configurations below, place the microswitches as shown.	
	●	☀	●	x 1 steady x 2 flashing x 3 steady	ON = red = contact closed OFF = orange = open tripped OFF = green = contact open
	●	☀	●		ON = red = contact closed OFF = orange = open tripped OFF = green = contact open SLAVE = duplicate function (handle position on MCCB)
	○	○	○	x 1 not used x 2 not used x 3 not used	<b>Image of hard-wired contacts</b> , only the bus information is enabled
	●	○	●	x 1 steady x 2 not used x 3 steady	Associated with a contactor or relay, <b>Image of hard-wired contacts</b>
	●	○	●		Associated with a contactor or relay, <b>Image of hard-wired contacts</b> SLAVE = duplicate function
	●	●	●	x 1 steady x 2 steady x 3 steady	<b>Image of hard-wired contacts</b>
	○	☀	○	x 1 not used x 2 flashing x 3 not used	<b>Associated with several fault contacts</b>
	●	●	●		Connected position Test position Drawn-out position
	●	●	●	x 1 steady x 2 steady x 3 steady	Connected position Test position Drawn-out position SLAVE = duplicate function
	●	●	●		Spring charged Ready to load Spring discharged
	●	●	●		Only possible on ACBs Spring charged Ready to load Spring discharged SLAVE = duplicate function

on off Microswitch on OFF      on off Microswitch on ON



Details and examples can be found in «CX<sup>3</sup> EMS Configuration Software» on page 80.

**VIEWING DATA**

The universal signalling module is used to transfer information fed back over the CX<sup>3</sup> EMS bus to the IP computer network, passing via the RS485 Modbus network. Various display modes are therefore possible:

Locally, in the enclosure, on mini-configurator Cat.No 4 149 36:

Remotely, on a PC, a tablet, a smartphone. The CX<sup>3</sup> EMS /RS485/ IP interfaces should be used in order to access devices such as the touch screen Cat. No 0 261 56, the Energy Management software Cat.No 4 149 38/39 and the Energy Web Servers Cat.No 4 149 47/48/49.

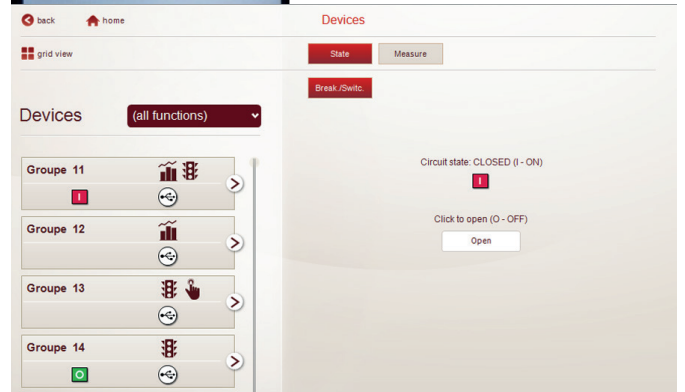
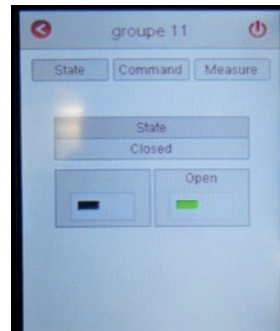
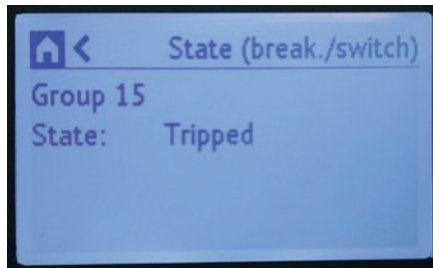
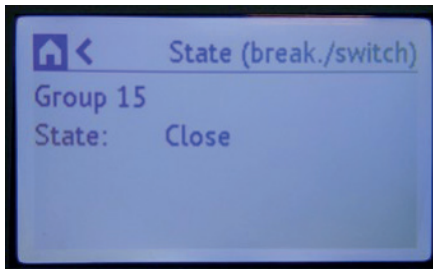

**i** For example: The tripped circuit breaker status appears on both the LED module (flashing orange) and on the mini-configurator screen.



## WIRING

### ■ Control contacts:

These are supplied to the module by volt-free contacts.

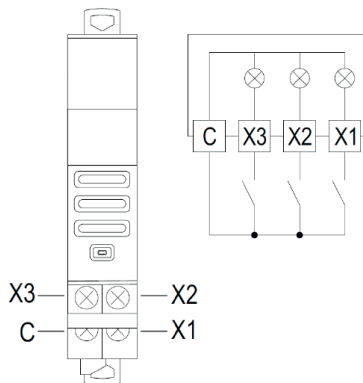

**i** You will find possible wiring examples on the module technical data sheet 4 149 30.

### ■ CX<sup>3</sup> EMS bus:

There are 2 possible solutions for connection to the bus:

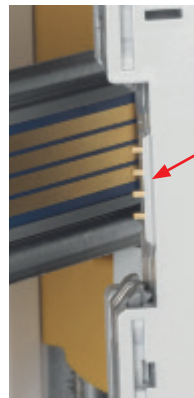

At the back of the modules via communication rail  
Cat. Nos  
4 149 01/02/03



At the bottom of the modules via communication cables  
Cat. Nos  
4 149 07/08/09

**i** The specifications for connection to the CX<sup>3</sup> EMS bus are common to all CX<sup>3</sup> EMS devices and are described in the product technical data sheets.

### RAIL CONNECTION



### CABLE CONNECTION

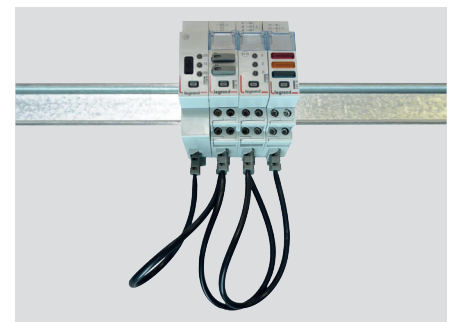

## WIRING (CONTINUED)

### ■ Integration in optimised distribution system:

The upper side terminals of the universal signalling module Cat.No 4 149 30 have been designed to allow single-phase and three-phase supply busbars to pass freely. Therefore, the module can integrate HX<sup>3</sup> optimised distribution systems. This allows to have a combination of functions in the same DIN rail. The signalling module is then as close as possible to the protection modules.



### OPTIMISED DISTRIBUTION POSSIBLE



## SETTING PARAMETERS

### ■ Choice of type of use:

As indicated in the paragraph «Product selection» on page 25, all 4 microswitches can be used to select the desired function for the module.

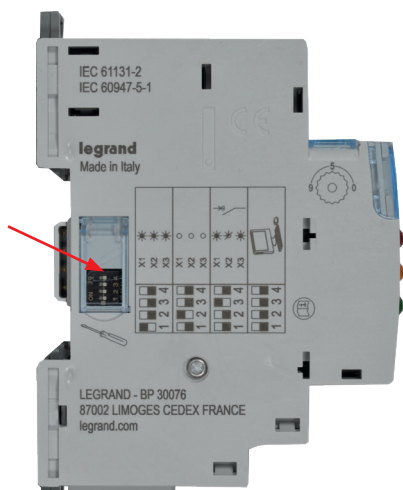

**i** The main settings are marked on the module. For the remaining settings you can refer to the technical data sheet or to this guide.

**i** The Setting parameters of the switches can be done by software, the switches present on the modules are configured by default to zero. Details and examples can be found in the section «CX<sup>3</sup> EMS configuration software» on page 80.

### ■ Additional Setting parameters:

Some universal signalling module applications require additional settings.

This is the case for the module associated with a contactor or a relay.

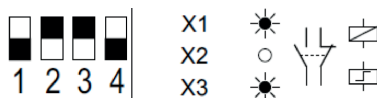

The additional settings linked to this function can be accessed by the CX<sup>3</sup> EMS configuration software.

It is possible to modify the number of associated contacts, name them, and change their NO, NC status.



**i** You can refer to the CX<sup>3</sup> EMS configuration software user's guide to find out all the options, available online.

### ■ Full settings by software programming:

The universal signalling module is supplied, in its default configuration, with the 4 switches on zero.

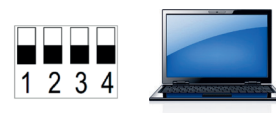

They can be left in this configuration, and all the settings can then be accessed by the EMS configuration software.

For the configurations mentioned in the table page 25, place the microswitches as shown.

In this case, the software allows access to other settings, such as:

- the name and active status of each input
- enabling and setting an alarm time delay on the input.



## SETTING PARAMETERS (CONTINUED)

### ■ «SLAVE» function:

Some configurations are available in SLAVE mode (slave = duplicate function).

This SLAVE mode is a solution for transferring information over the same bus, **avoiding** the need to hard-wire information.

**i** A universal signalling module in SLAVE mode must always be associated with a universal signalling module in "hard-wired" mode, a signalling auxiliary module or a DPX<sup>3</sup>/DMX<sup>3</sup> S10.

## DATA TRANSFER

The universal signaling module sends the information directly back to the CX<sup>3</sup> EMS bus, allowing the data to be transferred to an operating system. As seen on page 26 (paragraph «Viewing data»), information is available on the mini-configurator Cat.No 4 149 36, the touch screen Cat.No 0 261 56, the Energy Management software Cat.No 4 149 38/39 and the Energy Web Servers Cat.No 4 149 47/48/49.

The Modbus register tables are available for use by a system integrator. In this case, an CX<sup>3</sup> EMS / RS485 Modbus interface is required.

**i** For more details, please refer to the data sheet available on the online catalog.

## ADDRESSING

Addressing can be done:

- Locally on the product
  - addressing from 1 to 9 using a selector.
- Via software
  - addressing from 1 to 247,
  - the selector then stays on 0.

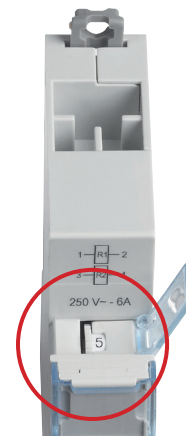

**i** The specifications for connection to the CX<sup>3</sup> EMS bus are common to all CX<sup>3</sup> EMS devices and are described in the product technical data sheets.

**!** Local setting using the selector takes priority over software Setting parameters. In the event of malfunction, check that the selector is definitely on zero.





# CX<sup>3</sup> EMS AUXILIARY + FAULT SIGNALLING MODULE

## Product specifications

AC + FS module Cat.No 4 149 29 is integrated in the CX<sup>3</sup> EMS system for monitoring energy in electrical panels.

It signals the status of the contacts "AC" and the fault "FS" on the associated modular product. This information is sent remotely over the CX<sup>3</sup> EMS bus. It is installed on the left-hand side of Legrand modular circuit breakers, RCBOs, RCDs, isolating switches with remote trip option.



### CHARACTERISTICS

■ **Display:**

No display on the module itself  
Data can be displayed locally (on mini-configurator Cat.No 4 149 36), or remotely (on a PC, tablet or smartphone screen).

■ **Supply voltage:**

12 VDC via EMS CX<sup>3</sup> power supply module Cat.No 4 149 45

■ **Consumption:** 19.7 mA - 0.236 W

■ **Conforming to standards:**  
IEC/EN 61131-2 (PLC)

■ **Connection:**

Power supply via communication rail or cables on the CX<sup>3</sup> EMS bus.

■ **Mounting:** DIN rail.

■ **Dimensions (width):** 1/2 module.

### PRODUCT SELECTION

AC + FS module Cat.No 4 149 29 is used if the “on/off/fault” status information of a DX<sup>3</sup> modular product such as MCBs, RCBs, etc are fed back to a management system.

### VIEWING DATA

The AC + FS module is used to transfer status information fed back over the EMS CX<sup>3</sup> bus to the IP computer network, passing via the RS485 Modbus network.

Various display modes are therefore possible:

- Locally, in the enclosure, on the mini-configurator Cat.No 4 149 36:

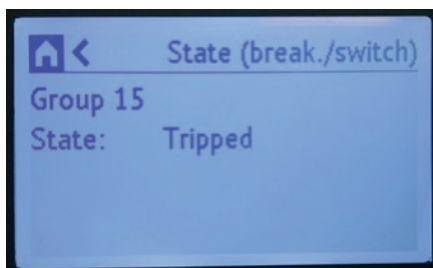
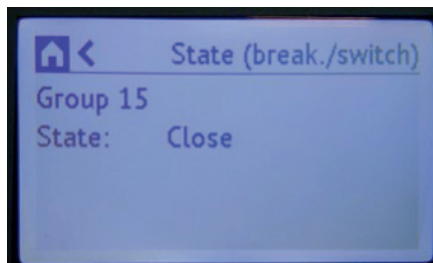

### VIEWING DATA (CONTINUED)

- Remotely, on a PC, a tablet, a smartphone. The CX<sup>3</sup> EMS / RS485 / IP interfaces should be used in order to access devices such as the touch screen Cat.No 0 261 56, the Energy Management software Cat.No 4 149 38/39 and the Energy Web Servers Cat.No 4 149 47/48/49.

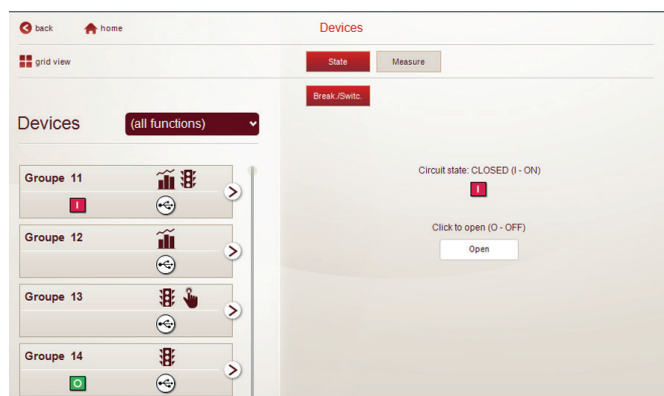
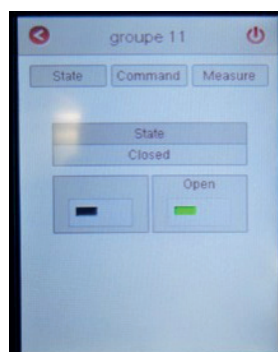

## MOUNTING

The AC + FS signalling auxiliary module is installed on the left-hand side of Legrand modular circuit breakers, RCBOs, RCDs, isolating switches with remote trip option.

Be careful to follow certain installation rules described in the product manuals and technical data sheets, available online.



**i** The module is mounted on the associated modular product in exactly the same like other DX<sup>3</sup> signalling auxiliaries.

**i** The table showing combinations with the various modular protection devices is available on the CX<sup>3</sup> EMS AC + FS module technical data sheet.

■ **CX<sup>3</sup> EMS bus:**

There are 2 possible solutions for connection to the bus:



At the back of the modules via communication rail  
Cat. Nos 4 149 01/02/03



At the bottom of the modules via communication cables  
Cat. Nos 4 149 07/08/09



The specifications for connection to the CX<sup>3</sup> EMS bus are common to all CX<sup>3</sup> EMS devices and are described in the product technical data sheets.

**RAIL CONNECTION**



**CABLE CONNECTION**

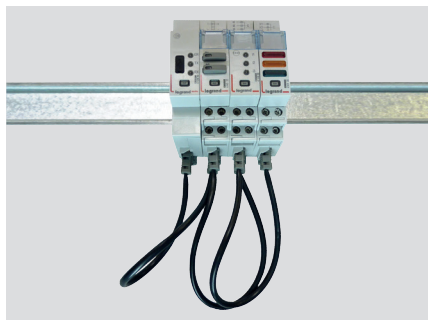

## SETTING PARAMETERS

Does not need any additional settings.

## DATA TRANSFER

The AC + FS module transfers information directly over the EMS CX<sup>3</sup> bus and can be used to feed back data to an operating system. As seen on page 33 (paragraph «Viewing data»), information is available on the mini-configurator Cat.No 4 149 36, the touch screen Cat.No 0 261 56, the Energy Management software Cat.No 4 149 38/39 and the Energy Web Servers Cat.No 4 149 47/48/49.

The Modbus register tables are made available for use by a system integrator.

In this case, an CX<sup>3</sup> EMS/RS485 Modbus interface is needed.

## ADDRESSING

Addressing can be done:

- Locally on the product
  - addressing from 1 to 9 using a selector.
- Via software
  - addressing from 1 to 247,
  - the selector then stays on 0.



**i** The specifications for connection to the CX<sup>3</sup> EMS bus are common to all CX<sup>3</sup> EMS devices and are described in the product technical data sheets.

**!** Local setting using the selector takes priority over software Setting parameters. In the event of malfunction, check that the selector is definitely on zero.



# CX<sup>3</sup> EMS

## UNIVERSAL CONTROL MODULE

### Product specifications

Universal control module  
Cat. No 4 149 32 is integrated in  
the EMS CX<sup>3</sup> system for monitoring  
energy in electrical panels.

It can be used to control various  
loads such as relays, contactors, as  
well as motorised controls for MCBs  
and MCCBs, regardless of brand.

Control can be done locally or  
remotely over the EMS CX<sup>3</sup> bus.

The control type parameters can be set  
by microswitches directly on the product.



#### CHARACTERISTICS

- **Display:**  
2 LEDs indicate the control unit ON/  
OFF status. Data can be displayed  
locally (on mini-configurator  
Cat. No 4 149 36), or remotely (on a  
PC, tablet or smartphone screen).
- **Supply voltage:**  
2 VDC via CX<sup>3</sup> EMS power supply  
module Cat.No 4 149 45
- **Control:**  
Via volt-free contacts 250 VAC – 6 A.
- **Maximum consumption:**  
38 mA - 0.456 W
- **Conforming to standards:**  
IEC/EN 61131-2 (PLC)
- **Connection:**
  - power supply via communication  
rail or cables on the CX<sup>3</sup> EMS bus
  - control via screw terminals.
- **Mounting:** DIN rail.
- **Dimensions (width):** 1 module.



Details and examples can be found in «CX<sup>3</sup> EMS Configuration Software» on page 80.



## PRODUCT SELECTION

Only one catalogue number to remember: 4 149 32. The setting of the different type of information is done with the help of 4 microswitches on the side of the module or by software programming.



SWITCH POSITION	R1 R2 CONTACT STATUS	DETAILS	SWITCH POSITION	R1 R2 CONTACT STATUS	DETAILS
		Software programming. Default configuration. In this case, the outputs are generic. 2 x 2NO relays. For the configurations below, place the microswitches as shown.			2 switch type linked controls R1 NO contact and R2 NC contact
		2 switch type separate controls R1 NO contact and R2 NC contact			2 switch type linked controls R1 NC contact and R2 NC contact
		2 push-button type separate controls R1 NO contact and R2 NO contact			2 switch type separate controls R1 NO contact and R2 NO contact Combined with a motorised circuit breaker
		2 push-button type linked controls R1 NO contact and R2 NC contact			2 push-button type linked controls R1 NO contact and R2 NO contact Combined with a motorised circuit breaker
		2 push-button type separate controls R1 NC contact and R2 NC contact			2 push-button type separate controls R1 NO contact and R2 NO contact Combined with a motorised circuit breaker
		2 switch type separate controls R1 NO contact and R2 NO contact			2 switch type linked controls R1 NO contact and R2 NC contact Combined with a motorised circuit breaker
		2 push-button type separate controls R1 NO contact and R2 NC contact			2 switch type linked controls R1 NO contact and R2 NO contact Combined with a contactor
		2 switch type separate controls R1 NC contact and R2 NC contact			2 push button type linked controls R1 NO contact and R2 NO contact Combined with a contactor

on Microswitch on OFF

on Microswitch on ON



Details and examples can be found in «CX<sup>3</sup> EMS Configuration Software» on page 80.

## VIEWING DATA

The universal control module is used to control various loads remotely via the EMS CX<sup>3</sup> bus to the IP computer network, passing via the Modbus RS485 network. Various control modes are therefore possible:

Locally, in the enclosure, on mini-configurator Cat.No 4 149 36:

Remotely, on a PC, a tablet, a smartphone.

The CX<sup>3</sup> EMS / RS485/IP interfaces should be used in order to access devices such as the touch screen Cat.No 0 26156, the Energy Management Software Cat.No 4 149 38/39 and the Energy Web Servers Cat.No 4 149 47/48/49.

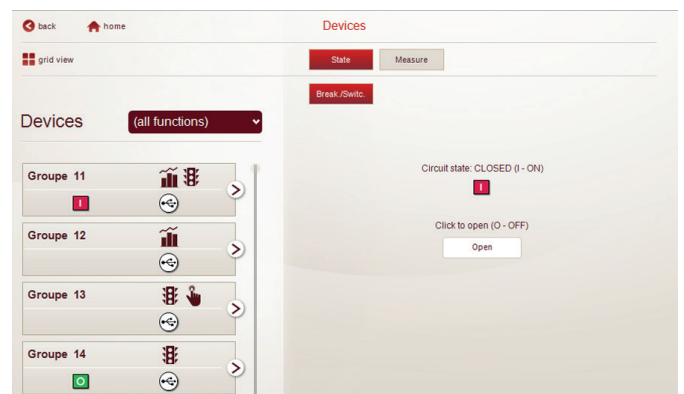
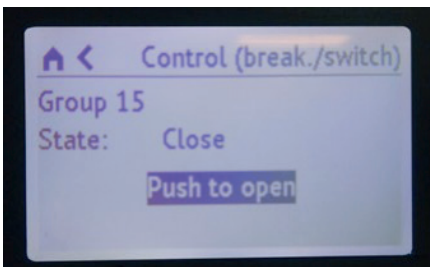
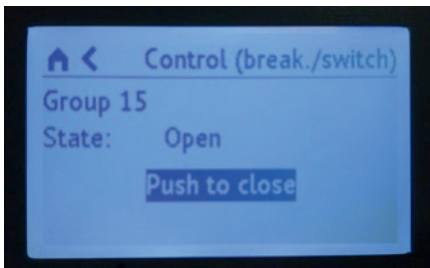

**i** Local control is also possible by pressing directly on the CX<sup>3</sup> EMS control module buttons.



## WIRING

### ■ Control contacts:

The module provides 2 volt-free contacts max 250 VAC - 6 A.

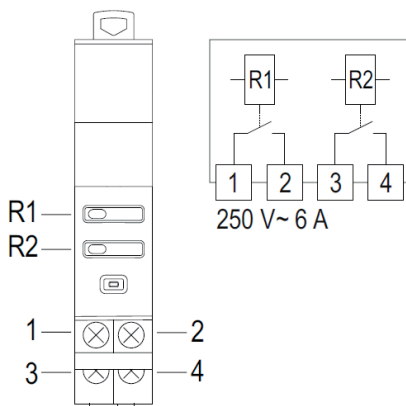

### ■ CX<sup>3</sup> EMS bus:

There are 2 possible solutions for connection to the bus:



At the back of the modules via communication rail  
Cat. Nos 4 149 01/02/03



At the bottom of the modules via communication cables  
Cat. Nos 4 149 07/08/09



The specifications for connection to the CX<sup>3</sup> EMS bus are common to all CX<sup>3</sup> EMS devices and are described in the product technical data sheets.



You will find possible wiring examples on the module technical data sheet 4 149 32, available online.

### RAIL CONNECTION



### CABLE CONNECTION

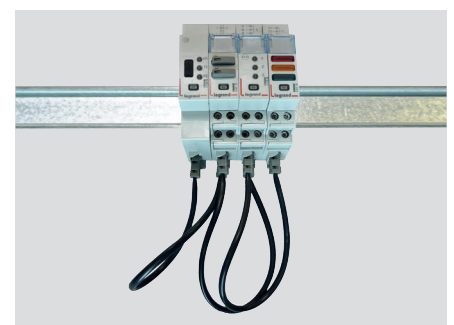

## WIRING (CONTNUED)

### ■ Integration in optimised distribution system:

The upper side terminals of the universal control module Cat.No 4 419 32 have been designed to allow single-phase and three-phase supply busbars to pass freely. Therefore, the module can integrate HX<sup>3</sup> optimised distribution systems. This allows to have a combination of functions in the same enclosure. The universal control module is then as close as possible to the protection modules.



### OPTIMISED DISTRIBUTION POSSIBLE



## SETTING PARAMETERS

### ■ Choice of type of function:

As indicated page 39 “Product selection” section, all 4 switches are used to select the desired function for the module.

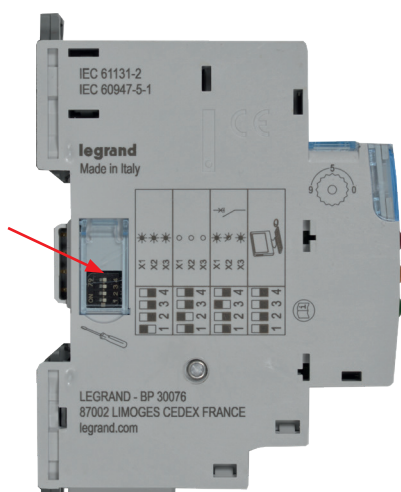

**i** The main settings are marked on the module. For the remaining settings you can refer to the technical data sheet or to this guide.

**i** The Setting parameters of the switches can be done by software. The switches present on the modules are factory set to zero. Details and examples can be found in the section «CX<sup>3</sup> EMS configuration software» on page 80.

### ■ Additional Setting parameters:

Some universal control module applications require additional settings.

This is the case for circuit breaker motorised controls.

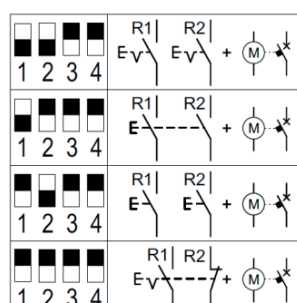

The additional settings linked to this function can be accessed by the CX<sup>3</sup> EMS configuration software. Depending on the modes, it is possible to modify elements such as the time and activation delay, type of control, pulse or maintained, etc.

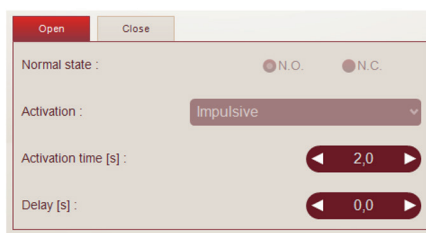

**i** You can refer to the CX<sup>3</sup> EMS configuration software user's guide to find out all the options, available online.

### ■ Full settings by software programming:

The universal control module is supplied, in its default configuration, with all 4 switches on zero.

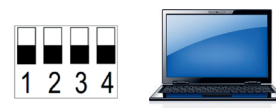

They can be left in this configuration, and all the settings can then be accessed by the CX<sup>3</sup> EMS configuration software. In this case, the software allows access to other settings, such as:

- the name and active status of the R1 and R2 relays
- locking of the 2 outputs
- etc.

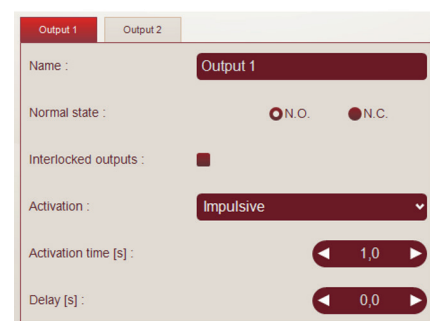

## DATA TRANSFER

The universal control module transfers information directly over the EMS CX<sup>3</sup> bus and can be used to transfer data to an operating system.

As seen on page 40 («Viewing data»), information is available on the mini-configurator Cat.No 4 149 36, the touch screen Cat.No 0 261 56, the Energy Management software Cat.No 4 149 38/39 and the Enegy Web Server Cat.No 4 149 47/48/49.

The Modbus register tables are made available for use by a system integrator.

In this case, an CX<sup>3</sup> EMS/RS485 Modbus interface is needed.

## ADDRESSING

Addressing can be done:

- Locally on the product
  - addressing from 1 to 9 using a selector.
- Via software
  - addressing from 1 to 247,
  - the selector then stays on 0.



**i** The specifications for connection to the CX<sup>3</sup> EMS bus are common to all CX<sup>3</sup> EMS devices and are described in the product technical data sheets.

**!** Local setting using the selector takes priority over software setting. In the event of malfunction, check that the selector is definitely on zero.



# CX<sup>3</sup> EMS CONTROL & STATE REPORTING MODULE

## Product specifications

Control and state reporting module  
Cat.No 4 149 31 is integrated in the  
CX<sup>3</sup> EMS system for monitoring  
energy in electrical panels.

It can be used to remotely control and  
view the status of 1 and 2 modules  
contactors up to 25 A, and also of  
Legrand pulse operated latching relays.

Control can be done locally or  
remotely over the EMS CX<sup>3</sup> bus.

The control type can be set by  
switches directly on the product.



### CHARACTERISTICS

- **Display:**  
Data can be displayed locally (on mini-configurator Cat. No 4 149 36), or remotely (on a PC, tablet or smartphone screen).
- **Supply voltage:**  
12 VDC via CX<sup>3</sup> EMS power supply module Cat.No 4 149 45.
- **Control:**  
via CX<sup>3</sup> EMS bus.
- **Consumption:** 31 mA - 0.372 W
- **Conforming to standards:**  
IEC/EN 61131-2 (PLC)
- **Connection**
  - power supply via communication rail or cables on the CX<sup>3</sup> EMS bus
  - control via screw terminals.
- **Mounting:** DIN rail.
- **Dimensions (width):** 1 module.



## PRODUCT SELECTION

Only one catalogue number to remember: 4 149 31. The setting of different type of associated product is done with the help of 4 microswitches on the side of the module.

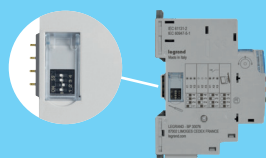

SWITCH POSITION	CAN BE USED WITH	DETAILS	COMPATIBLE CATALOGUE NUMBERS
 1 2 3 4		Default configuration	The parameters of this module are only set by the 4 switches - the system will not be able to take this default configuration into account.
 1 2 3 4	 1 module	<b>Pulse operated latching relay</b> 1 module	4 124 04 - 4 124 05 - 4 124 08 - 4 124 10 - 4 124 11 - 4 124 12 - 4 124 20
 1 2 3 4	 2 modules	<b>Pulse operated latching relay</b> 2 modules	4 124 14 - 4 124 16
 1 2 3 4	 1 module	<b>Contacteur</b> <b>With handle</b> - 1 module	4 125 14 - 4 125 58 - 4 125 44
 1 2 3 4	 2 modules	<b>Contacteur</b> <b>With handle</b> - 2 modules	4 125 17 - 4 125 51 - 4 125 61
 1 2 3 4	 1 module	<b>Contactor</b> <b>Without handle</b> - 1 module	4 125 03 - 4 125 05 - 4 125 21 - 4 125 23 - 4 125 24
 1 2 3 4	 2 modules	<b>Contactor</b> <b>Without handle</b> - 2 modules	4 125 09 - 4 125 10 - 4 125 33 - 4 125 35 - 4 125 36
 1 2 3 4	 1 module	<b>Peak hours/Off-peak hours contactor</b> 1 module	4 125 00 - 4 125 01 Only for the state reporting
 1 2 3 4	 2 modules	<b>Peak hours/Off-peak hours contactor</b> 2 modules	4 125 02 Only for the state reporting

on off **Microswitch on OFF**

on off **Microswitch on ON**

**MOUNTING:**

No tool is needed for mounting. CX<sup>3</sup> EMS control and state reporting module is mounted on the left-hand side of the CX<sup>3</sup> products listed previously.

This must be done when the CX<sup>3</sup> product is in the rest position.

Be careful to follow the installation rules described in the product manuals and technical data sheet.

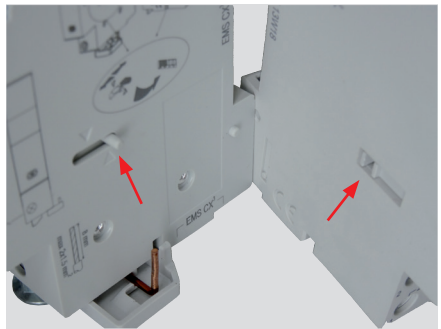

Make sure you correctly position the plastic ferrule on the CX<sup>3</sup> EMS module towards the back, facing the notch in the product to be joined to it.



Make sure to insert the copper connector into the corresponding terminal before mechanically assembling the modules.



Continue with mechanical assembly.

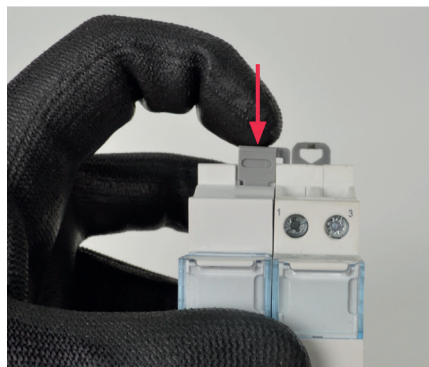

Lock the assembly.

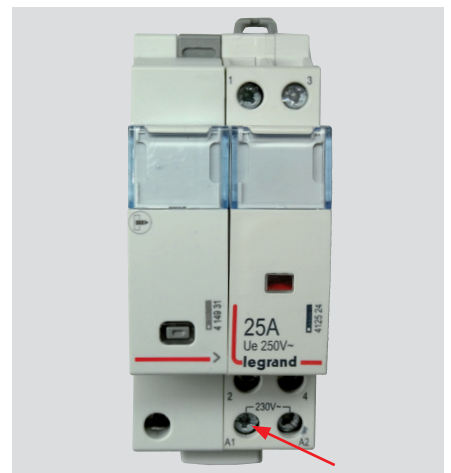

Don't forget to screw the terminal electrically linking the 2 products.

The assembly is then ready to be wired up.

**i** Example of use: remote control of a push-button/pulse operated latching relay assembly.

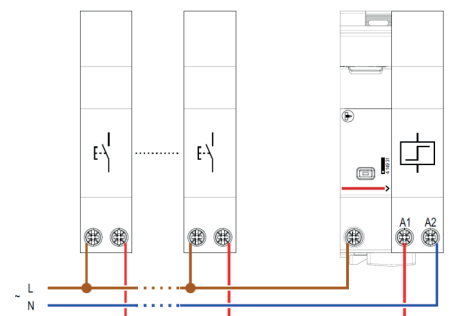

### VIEWING DATA:

The control and state reporting module is used to control and transfer information over the CX<sup>3</sup> EMS bus to the IP computer network, passing via the RS485 Modbus network. Various display and control modes are therefore possible:

Locally, in the enclosure, on mini-configurator Cat.No 4 149 36:

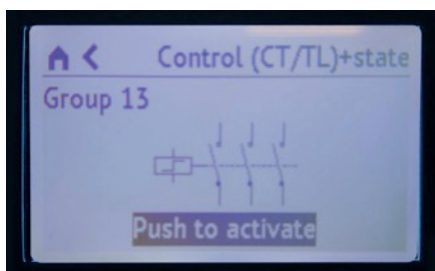
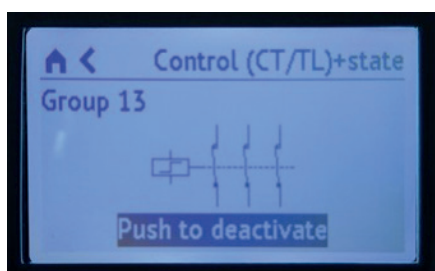

Remotely, on a PC, a tablet, a smartphone. The CX<sup>3</sup> EMS / RS485 / IP interfaces should be used in order to access devices such as the touch screen Cat.No 0 261 56, the Energy Management software Cat.No 4 149 38/39 and the Energy Web Servers Cat.No 4 149 47/48/49.

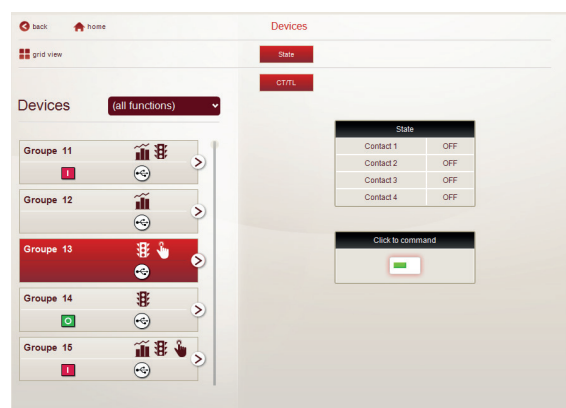

**i** For example: The pulse operated latching relay status appears on the mini-configurator screen and remote control is possible.

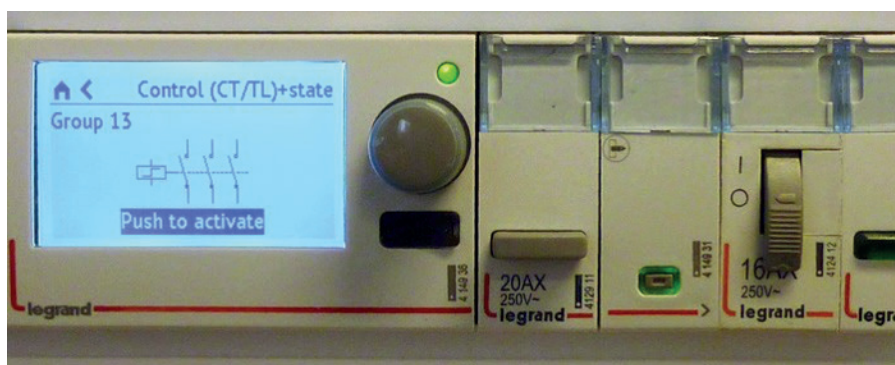

## WIRING

### ■ Control:

The pulse operated latching relay or the contactors are controlled via the CX<sup>3</sup> EMS bus; simply connect the phase to the terminal as shown below.



**i** You will find possible wiring examples on the module technical data sheet 4 149 31, available online.

### ■ CX<sup>3</sup> EMS bus:

There are 2 possible solutions for connection to the bus:



At the back of the modules via communication rail  
Cat. Nos 4 149 01/02/03



At the bottom of the modules via communication cable  
Cat. No 4 149 07/08/09

**i** The CX<sup>3</sup> EMS bus connection specifications are common to all EMS CX<sup>3</sup> products and are detailed in the product data sheets.

### RAIL CONNECTION



### CABLE CONNECTION

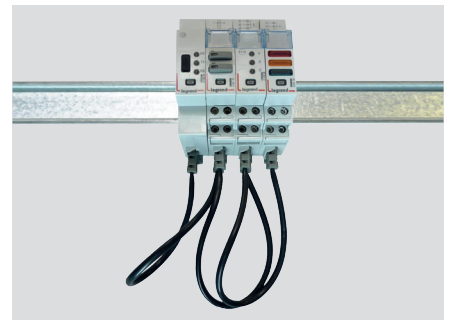

## WIRING (CONTINUED)

### ■ Integration in optimised distribution system:

The upper side terminals of the control and state reporting module have been designed to allow single-phase and three-phase supply busbars to pass freely. Therefore the module can integrate HX<sup>3</sup> optimised distribution systems. This allows to have a combination of functions in the same enclosure. The control and state reporting module is then as close as possible to the protection modules.



### OPTIMISED DISTRIBUTION POSSIBLE



## SETTING PARAMETERS

### ■ Choice of type of use:

As indicated on page 47 “Product selection”, the 4 switches are used to select the desired function for the module.

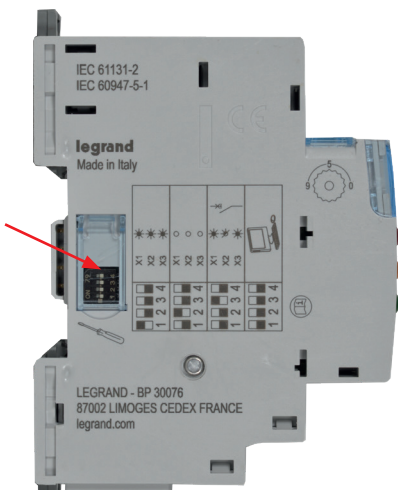

**i** The main settings are marked on the module. For the remaining settings you can refer to the technical data sheet or to this guide.

### ■ Additional Setting parameters:

All the control and state reporting module applications have additional settings. They can be accessed via the CX<sup>3</sup> EMS configuration software.

It is possible to modify the number of associated contacts, name them, change their NO, NC status, and add a time delay.

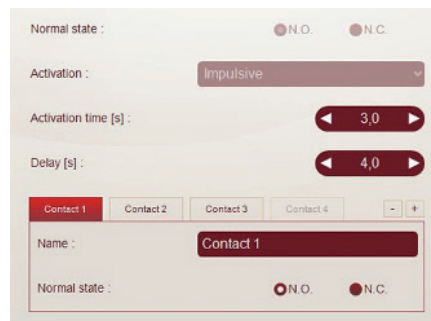

**i** You can refer to the CX<sup>3</sup> EMS configuration software user's guide to find out all the options, available online.

### ■ Full settings by software programming:

The control and state reporting module is supplied, in its default configuration, with all 4 switches on zero.

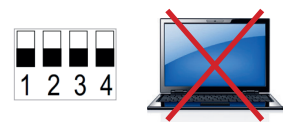

Unlike the other modules, the control and state reporting module **MUST** be set with the 4 switches.

**!** Setting parameters via the EMS configuration software takes into account only the additional settings. Therefore, do not leave the 4 switches on zero position.

## DATA TRANSFER

The control and state reporting module transfers the information about the state of the associated pulse operated latching relay or CX<sup>3</sup> contactor directly over the CX<sup>3</sup> EMS bus and can thus be used to bring up data to an operating system.

The coil of the associated CX<sup>3</sup> device can therefore be controlled remotely by the same operating system.

As seen on page 49 (paragraph «Viewing data»), information is available on the mini configurator Cat.No 4 149 36, the touch screen Cat.No 0 261 56, the Energy Management Software Cat.No 4 149 38/39 and the Energy Web servers Cat.No 4 149 47/48/49.

The Modbus register tables are made available for use by a system integrator.

In this case, an CX<sup>3</sup> EMS/RS485 Modbus interface is needed.

## ADDRESSING

Addressing can be done:

- Locally on the product
  - addressing from 1 to 9 using a selector.
- Via software
  - addressing from 1 to 247
  - the selector then stays on 0.

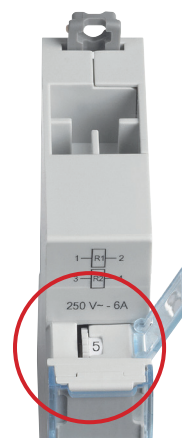

**i** The CX<sup>3</sup> EMS bus connection specifications are common to all CX<sup>3</sup> EMS products and are detailed in the product data sheets.

**!** Local setting using the selector takes priority over software setting. In the event of malfunction, check that the selector is definitely on zero.

# CX<sup>3</sup> EMS

## POWER SUPPLY MODULE

### Product specifications

Power supply module

Cat. No 4 149 45 is part of the CX<sup>3</sup> EMS modular system for monitoring energy in electrical panels.

Only this power supply dedicated to the CX<sup>3</sup> EMS system can be used.

This module supplies power by means of the communication rail and/or cables.



#### CHARACTERISTICS

- **Display:** none
- **Power supply:** primary 95 to 250 VAC  
secondary 12 VDC 0.5A
- **Setting parameters:** none
- **Addressing:** none
- **Connection:**
  - power supply via screw terminals
  - power supply distribution via cables or dedicated rail.
- **Mounting:** DIN rail.
- **Dimensions (width):** 1 module.
- **Supplied** with a white cable for galvanic isolation.



## PRODUCT SELECTION

The number of power supplies Cat.No 4 149 45 in an CX<sup>3</sup> EMS system depends on how much power is needed for the modules to work correctly.

One power supply module can provide up to **500 mA**. If the installation needs a higher power rating, an additional power supply module must be installed. A single EMS CX<sup>3</sup> bus must not exceed 1.5 A: i.e. **3 power supply modules maximum**.

The total number of modules permitted with one power supply depends on their total consumption.

**1 CX<sup>3</sup> EMS system  
1 power supply module**

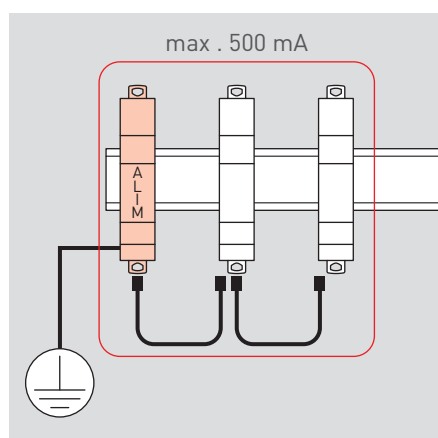

**1 CX<sup>3</sup> EMS system  
2 power supply modules**

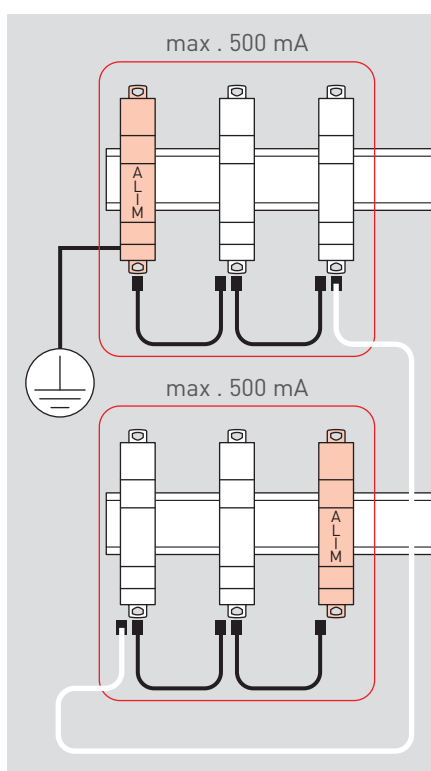

**1 CX<sup>3</sup> EMS system  
3 power supply modules**

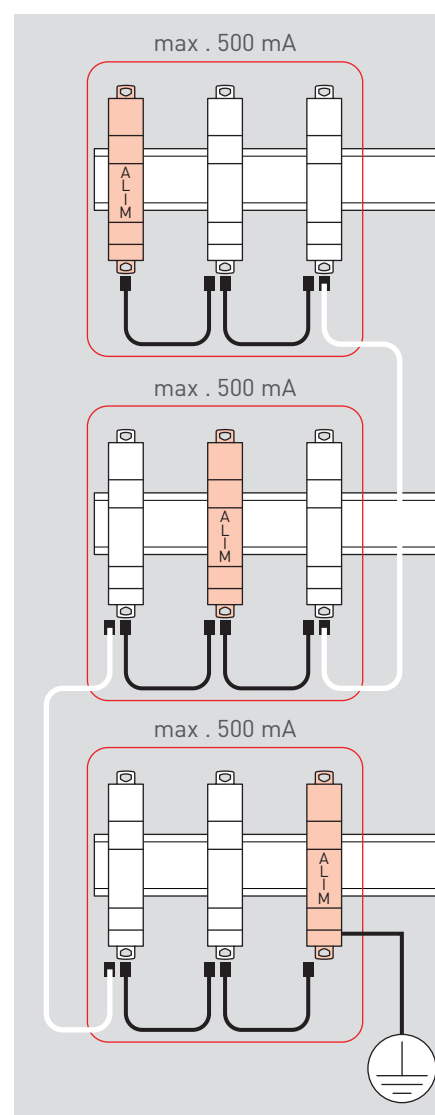

**i** If there are 1 or 2 power supplies, they should be installed at each end of the CX<sup>3</sup> EMS system.

If there are 3 power supplies, 2 should be installed at each end of the CX<sup>3</sup> EMS system, and the 3rd in the middle. Caution, each set must be connected with a white cable.

**i** 2 power supplies cannot be installed on the same communication rail.

**!** Each set consisting of “one power supply module and its CX<sup>3</sup> EMS modules” should be separated with a special link which must include a white cable (supplied with every power supply module).

**!** If there are a more than one of power supply modules in the same system, only one module should be earthed.

**PRODUCT SELECTION (CONTINUED)**

**!** One power supply module can provide up to 500 mA, so consumption must be calculated in order for the installation to work correctly.

**i** The white cable provided with the power supply module is 250 mm long. If a longer cable is needed, an extension can be created using “conventional” (black) CX<sup>3</sup> EMS cables and extension connectors. Maximum length of assembly: 3 m.

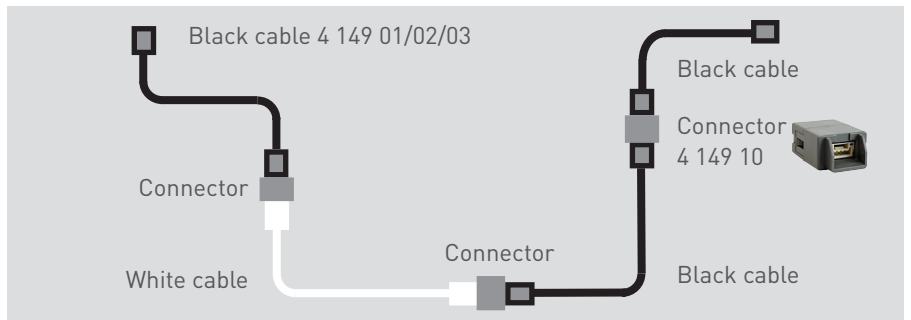

**CX<sup>3</sup> EMS modules power consumption**

CAT.NO	DESCRIPTION	MAXIMUM CONSUMPTION
4 149 18	Single-phase measurement module with 3 digital inputs up to 63 A	34.8 mA
4 149 19	Single-phase measurement module with digital input up to 63 A	34.1 mA
4 149 20	Three-phase measurement module with digital input up to 63 A	34.8 mA
4 149 21	Three-phase measurement module with 3 digital inputs up to 125 A	34.8 mA
4 149 22	Three-phase measurement module + open flexible Coil 630 A 1MOD	34.8 mA
4 149 23	High current measurement module	32.6 mA
4 149 24	Three-phase measurement module + open flexible Coil 1600 A 1MOD	34.8 mA
4 149 25	Three-phase measurement module + open flexible Coil 3200 A 1MOD	34.8 mA
4 149 26	Pulse concentrator module	24.0 mA
4 149 27	Three-phase measurement module + open flexible Coil 6300 A 1MOD	34.8 mA
4 149 29	AC + FS module (Auxiliary + fault signalling contact)	19.7 mA

CAT.NO	DESCRIPTION	MAXIMUM CONSUMPTION
4 149 30	Universal signalling module	31.4 m
4 149 31	Control and state report module	31.0 mA
4 149 32	Universal control module	38.0 mA
4 149 36	Local mini-configurator	36.5 mA
4 149 40	CX <sup>3</sup> EMS/RS485 interface	28.7 mA
4 238 90	CX <sup>3</sup> EMS/DPX <sup>3</sup> interface	27 mA
DPX <sup>3</sup> 250 HP S10	DPX <sup>3</sup> 250HP ELE S10, ELE S10 + RCD	101 mA (interface + connected device)
DPX <sup>3</sup> 250 HP S10 + PMD	DPX <sup>3</sup> 250 HP ELE S10 + measure, ELE S10 + RCD + measure	127 mA (interface + connected device)
DPX <sup>3</sup> 630/1600 S10	DPX <sup>3</sup> 630/1600 ELE S10	101 mA (interface + connected device)
DPX <sup>3</sup> 630/1600 S10 + PMD	DPX <sup>3</sup> 630/1600 ELE S10 + measure	127 mA (interface + connected device)
0 283 01 / 0 283 05	Protection unit MP2.10 with measure (for DMX <sup>3</sup> )	69 mA
0 283 00 / 0 283 04	Protection unit MP2.10 with measure (for DMX <sup>3</sup> )	55 mA
0 283 03 / 0283 07	Protection unit MP4.10 with measure (for DMX <sup>3</sup> )	80 mA
0 283 02 / 0283 06	Protection unit MP4.10 with measure (for DMX <sup>3</sup> )	62,5 mA

## WIRING

### ■ Power supply module:

Screw connection on the lower side of the module



### ■ CX<sup>3</sup> EMS bus:

There are 2 possible solutions for connection to the bus:



At the back of the modules via communication rail  
Cat. Nos 4 149 01/02/03

At the bottom of the modules via communication cables  
Cat. Nos 4 149 07/08/09



The CX<sup>3</sup> EMS bus connection specifications are common to all CX<sup>3</sup> EMS products and are detailed in the product data sheets.



To protect the power supply module, refer to the information in the product technical data sheet.



# CX<sup>3</sup> EMS

## ACCESSORIES & CONNECTIONS

### Product specifications

Data can be connected via the CX<sup>3</sup> EMS bus with the help of communication rails and/or cables.

Accessories such as extension connectors and protective covers for rails are available, making the CX<sup>3</sup> EMS communication system easy to use.



Communication rail

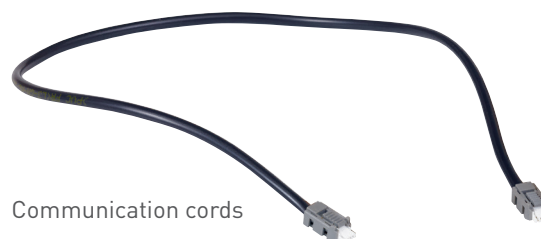

Communication cords



Protective for rail cover

#### CHARACTERISTICS

- **Rail**  
communication rail equipped with 4 printed circuits
- **Cable**  
communication cable equipped with 2 JST connectors
- **Cover**  
plastic cover
- **Extension connector**  
connector fitted with 2 JST "female" connectors



Extension connector

## PRODUCT SELECTION

	CAT.NO	DETAILS
<b>Communication rail</b> 	4 149 01	1 rail for 18 DIN modules – 315 mm long
	4 149 02	1 rail for 24 DIN modules – 420 mm long
	4 149 03	1 rail for 36 DIN modules – 630 mm long
<b>Communication cable</b> 	4 149 07	1 pack of 10 cables – 250 mm long
	4 149 08	1 pack of 10 cables – 500 mm long
	4 149 09	1 pack of 5 cables – 1000 mm long
<b>Extension connector</b> 	4 149 10	1 pack of 5 extension connectors
<b>Protective for rail cover</b> 	4 149 14	1 plastic protective cover for rail - 630 mm long

**i** 3 rail lengths are included in the catalogue, however it is possible to obtain different lengths by selecting the bespoke version. Please discuss this with your Legrand contact (check the back cover).

## MOUNTING

### ■ CX<sup>3</sup> EMS communication rail:

The communication rail is available in 3 lengths (18, 24, 36 modules) so it can be clipped onto any DIN rail.

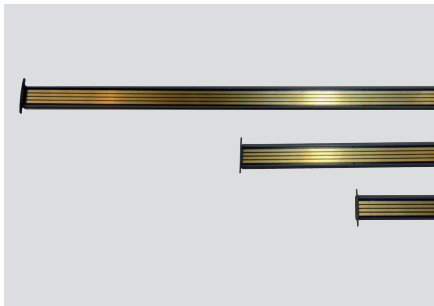

 No cutting or sawing required.



The communication rail clips onto 2 DIN rail models: 7.5 or 15 mm thick.

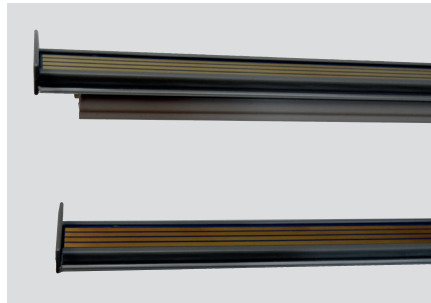

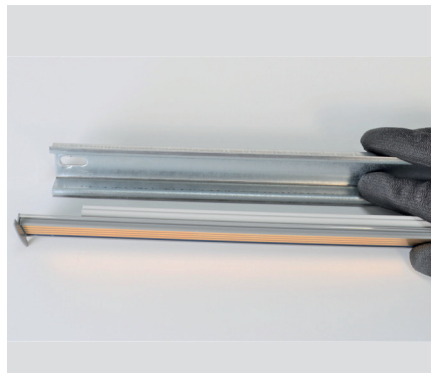

Simply clip the communication rail onto a 15 mm thick DIN rail.

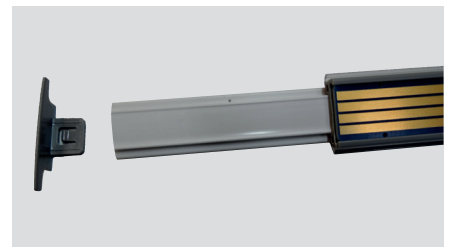

Clipping the communication rail onto a 7.5 mm thick DIN rail. This involves removing one of the tabs; slide the spacer to remove it, and replace the end.



 The tabs should then be replaced.

 The communication rail should be clipped onto DIN rails of the same length.



## MOUNTING (CONTINUED)

### ■ CX<sup>3</sup> EMS communication rail protection:

The unused part of the communication rail must be protected by the plastic cover.

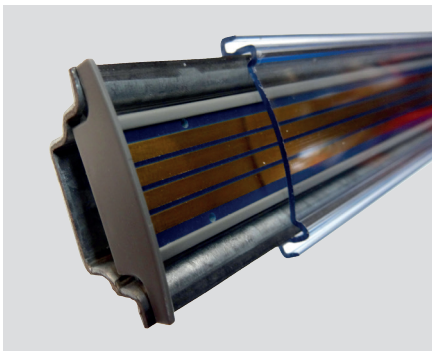

The cover can be cut to the required length.



**!** A visible rail which is not protected against direct contact can be responsible for a short-circuit on the CX<sup>3</sup> EMS bus.

### ■ CX<sup>3</sup> EMS communication cable:

Communication cables are available in 3 lengths: 250, 500, 1000 mm.

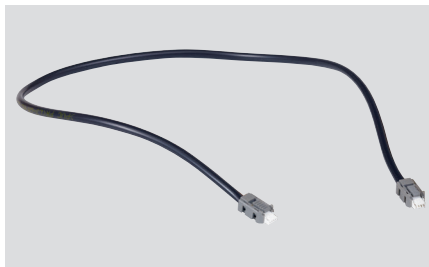

**!** You can make your own cable. We cannot guarantee it will work.

We offer an extension connector which can be used to extend the cable length.

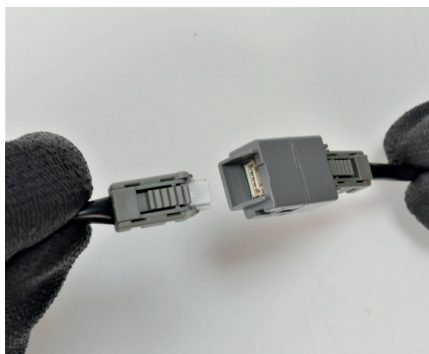

Cables link the CX<sup>3</sup> EMS modules.



Cables link 2 communication rails by linking 2 CX<sup>3</sup> EMS modules.



**!** The maximum length of a cable or “cables + connectors” or “cables + connectors + communication rails” must be less than 3 m.

## WIRING

There are 2 ways to connect CX<sup>3</sup> EMS modules:

- Via the communication rail. To do this, you need to remove the plastic protection from the rear communication ports of the modules.

- Via cables which connect to the bottom of each module.

Each CX<sup>3</sup> EMS module has 2 bus connectors.



**!** To avoid damaging the rail or the connections, the module should not be moved along the communication rail once fitted.

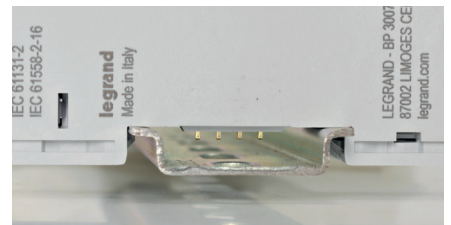

**i** A module whose protection has been removed can be used on a single DIN rail. We recommend protecting the module against any contact by adding insulation of your choice on the DIN rail.

**i** The 2 types of connection can be used in the same enclosure.



# CX<sup>3</sup> EMS/RS485 INTERFACE

## Product specifications

The CX<sup>3</sup> EMS/RS485 communication interface Cat.No 4 149 40 is used to convert data from the CX<sup>3</sup> EMS network to the RS485 Modbus network, so the data can be displayed and used outside the enclosure.



### CHARACTERISTICS

- **CX<sup>3</sup> EMS/RS485 interface**  
Cat.No 4 149 40.
- **Supply voltage:** 12 VDC via CX<sup>3</sup> EMS power supply module Cat.No 4 149 45.
- **Maximum consumption:**  
28,7 mA - 0.344 W
- **Mounting:** DIN rail.
- **Dimensions (width):** 1 module.
- **Output:**
  - by specific communicating cords (Cat. Nos 4 149 07/08/09) for a downstream connection via dedicated connectors (maximum length of a communicating cord that can be obtained with the extension piece Cat.No 4 149 10: 3 meters)
  - by specific communicating rails (Cat. Nos 4 149 01/02/03) for a rear connection via dedicated connectors.
- **Equipped with 3 LEDs:**
  - ER = error
  - TX = Transmission
  - RX = Reception

## PRODUCT SELECTION

The CX<sup>3</sup> EMS/RS485 interface can be used with any RS485 product which needs a MODBUS connection.

## WIRING

- 12 VDC power supply created by the CX<sup>3</sup> EMS bus via communication rail or cable. **(1)**
- Connection to the EMS CX<sup>3</sup> bus via communication rail or cable **(1)**
- Connection to the RS485 bus via 2 RJ45 connectors for easier connection. **(2)** If the interface is at the end of the RS485 bus, consider swapping the 120 ohm line termination resistor on the side of the RJ45 connections. **(3)**
- The USB port on the front **(4)** is used to connect a PC in order to configure the CX<sup>3</sup> EMS modules.

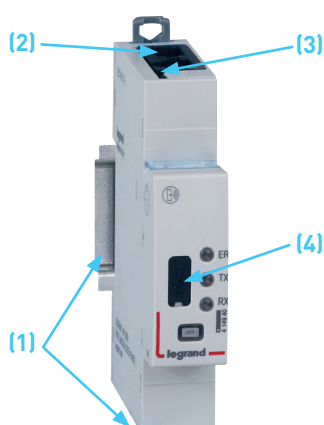

## WIRING (CONTINUED)

### ■ CX<sup>3</sup> EMS bus:

There are 2 possible solutions for connection to the bus:



At the back of the modules via communication rail  
Cat.Nos 4 149 01/02/03

At the bottom of the modules via communication cables  
Cat.Nos 4 149 07/08/09



The CX<sup>3</sup> EMS bus connection specifications are common to all CX<sup>3</sup> EMS products and are detailed in the product data sheets.



Use of the configuration software is described in the "CX<sup>3</sup> EMS configuration software" section (see page 80).

## SETTING PARAMETERS

On the CX<sup>3</sup> EMS/RS485 interface, the Modbus communication parameters are not necessarily set manually.

The CX<sup>3</sup> EMS/RS485 interface automatically takes the same Modbus settings as the RS485/IP interface connected on the same bus.

### Characteristics:

- Connection: RJ45, pin 4(-), pin5(+), pin 8(SG)
- Bit rate: 1.2 / 2.4 / 4.8 / 9.6 / 19.2 / 38.4 / 57.6 / 115 kbps
- Parity: even, odd, none
- Mode: RTU
- Stop bit: 1 / 2

## ADDRESSING

Addressing can be done:

- Locally on the product
  - addressing from 1 to 9 using the selector.
- Via software
  - addressing from 1 to 247,
  - the selector then stays on 0.



**i** The CX<sup>3</sup> EMS bus connection specifications are common to all CX<sup>3</sup> EMS products and are detailed in the product data sheets.

**!** Local setting using the selector takes priority over software Setting parameters. In the event of malfunction, check that the selector is definitely on zero.



# CX<sup>3</sup> EMS/DPX<sup>3</sup> INTERFACE

## Product specifications

The CX<sup>3</sup> EMS/DPX<sup>3</sup> communication interface Cat.No 4 238 90 is used to convert data from the DPX<sup>3</sup> circuit-breaker to the CX<sup>3</sup> EMS network to integrate DPX<sup>3</sup> into an EMS system/network.



### CHARACTERISTICS

- **CX<sup>3</sup> EMS/DPX<sup>3</sup> interface**  
Cat.No 4 238 90.
- **Supply voltage:** 12 VDC via CX<sup>3</sup> EMS power supply module Cat.No 4 149 45.
- **Maximum consumption:**  
27 mA - 0.324 W
- **Mounting:** DIN rail.
- **Dimensions (width):** 1 module.
- **Output:**
  - by specific communicating cords [Cat.Nos 4 149 07/08/09] for a downstream connection via dedicated connectors (maximum length of a communicating cord that can be obtained with the extension piece Cat.No 4 149 10: 3 meters).
  - by specific communicating rails [Cat.Nos 4 149 01/02/03] for a rear connection via dedicated connectors.
  - by specific cable (length: 2 meters) Cat. No 9 812 43 to the DPX<sup>3</sup> circuit breaker.
- **Equipped with 3 LEDs:**
  - ER = Error
  - TX = Transmission
  - RX = Reception



## PRODUCT SELECTION

The CX<sup>3</sup> EMS/DPX<sup>3</sup> interface can be used with S10 electronic circuit breakers (DPX<sup>3</sup> 250 HP/DPX<sup>3</sup> 1600) that require an EMS connection.

## WIRING

- 12 VDC power supply created by the CX<sup>3</sup> EMS bus via communication rail or cable **(1)**
- Connection to the CX<sup>3</sup> EMS bus via communication rail or cable **(1)**
- Connection to the DPX<sup>3</sup> circuit breaker with a specific cable (2m) to be plugged on the top of the interface **(2)**



## WIRING (CONTINUED)

### ■ CX<sup>3</sup> EMS bus:

There are 2 possible solutions for connection to the bus:



At the back of the modules via communication rail  
Cat.Nos 4 149 01/02/03



At the bottom of the modules via communication cables  
Cat.Nos 4 149 07/08/09

**i** The CX<sup>3</sup> EMS bus connection specifications are common to all CX<sup>3</sup> EMS products and are detailed in the product data sheets.

**i** Use of the configuration software is described in the “CX<sup>3</sup> EMS configuration software” section (see page 80).

### SETTING PARAMETERS

On the CX<sup>3</sup> EMS/DPX<sup>3</sup> interface, setting the EMS communication parameters is not necessary.

#### Characteristics:

- Connection: specific cable (2m) connecting the interface (on top) to the DPX<sup>3</sup>

### ADDRESSING

Addressing can be done:

- Locally on the product
  - addressing from 1 to 9 using the selector.
- Via software
  - addressing from 1 to 247,
  - the selector then stays on 0.



**i** The CX<sup>3</sup> EMS bus connection specifications are common to all CX<sup>3</sup> EMS products and are detailed in the product data sheets.

**!** Local setting using the selector takes priority over software Setting parameters. In the event of malfunction, check that the selector is definitely on zero.



# CX<sup>3</sup> EMS

## MINI-CONFIGURATOR

### Product specifications

The mini-configurator is integrated in the CX<sup>3</sup> EMS system for monitoring energy in electrical panels.

It is used locally, inside the enclosure to view all the energy monitoring data such as measurement, status and alarms, and also to control a circuit. It is an optional product, but is ideal for installations where there is a need for viewing and control from a unique point, directly at the enclosure level.



#### CHARACTERISTICS

- **Display:**
  - 2 inch backlit LCD screen
  - Resolution 240x128 pixels
  - Backlight fades automatically after 20 seconds' inactivity.
- **Configurable:**
  - Brightness
  - Backlight time
- **Security:**
  - A code can be set up (0000 by default) to access the settings.
- **Supply voltage:** 12 VDC via CX<sup>3</sup> EMS power supply module Cat.No 4 149 45.
- **Maximum consumption:** 36.5 mA - 0.438 W
- **Output:**
  - Via communication rail or cable on the CX<sup>3</sup> EMS bus.
- **Mounting:** DIN rail.
- **Dimensions (width):** 4 modules.
- **Equipped** with a B type Micro USB port to connect 1 PC.

## PRODUCT SELECTION

The CX<sup>3</sup> EMS mini-configurator Cat.No 4 149 36 should be chosen for local viewing in the enclosure.

It is used to display all the energy supervising data such as measurement, status, control and alarms.

The installation of the mini-configurator is not mandatory in order for the CX<sup>3</sup> EMS system to work properly. It can be proposed as an option.

## MENUS OVERVIEW

### ■ « Home » menu

In the original configuration, the below screen is proposed, but this can be changed in the settings.

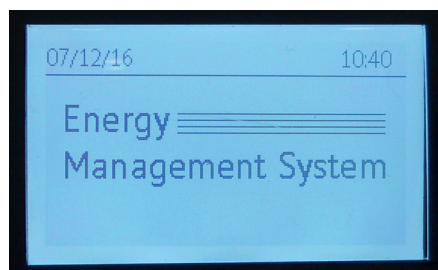

The mini-configurator is used by pressing or rotating the button on the front of the device.

## MENUS OVERVIEW (CONTINUED)

### ■ « Home » menu (continued)

Here are some examples of home page configuration

-> 2 lines of text to be configured:

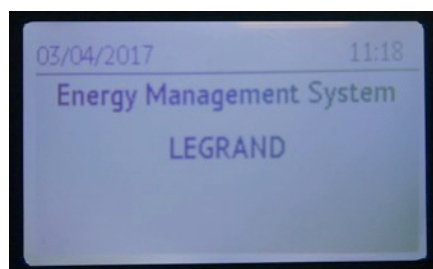

-> Cyclic display of measurements from a chosen circuit:

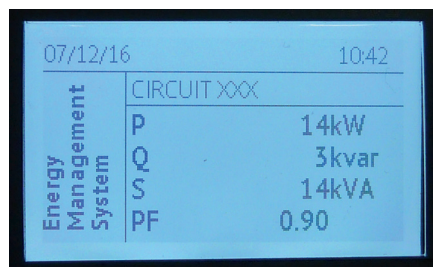
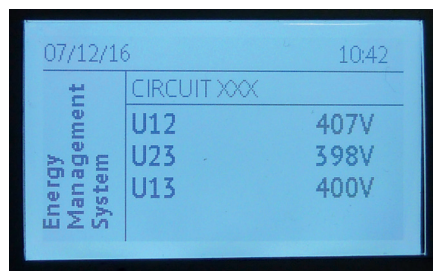

### ■ « View » menu

This provides access to various menus as follows:

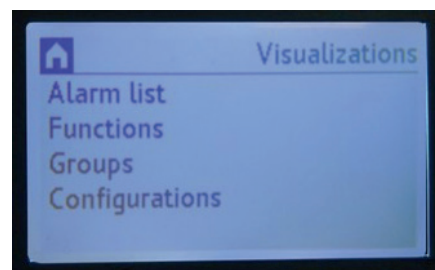

### ■ « Alarm list » menu

The CX<sup>3</sup> EMS mini-configurator keeps in memory the last 20 alarms. It shows the name of the group, type of fault, date and time.

Example of a circuit breaker trip:

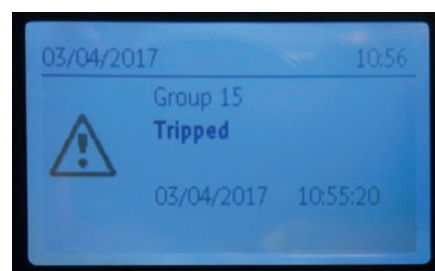

Example of a configuration error:

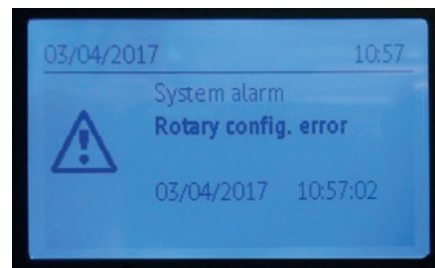

## MENUS OVERVIEW (CONTINUED)

### ■ « Function » menu

Provides a list of the various modules in the installation classified by function.

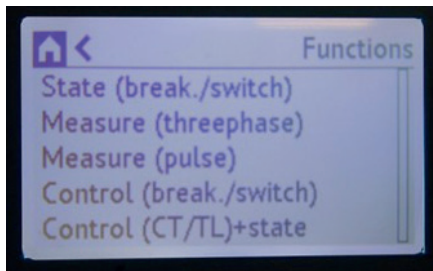

### ■ « Group » menu

Provides a list of the various modules in the installation classified by group.

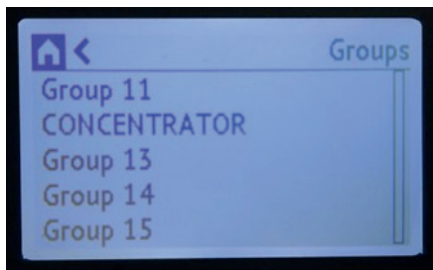

### ■ « Configuration » menu

Gives access to the various possible configurations.

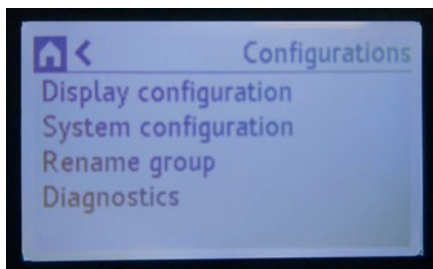

### ■ Examples of display

Energies:

Energies		
Ea+	Tot.	300000 kvarh
Ea-	L1	7000 kvarh
Er+	L2	8000 kvarh
Er-	L3	9000 kvarh

Powers:

Power		
P	P	2 kW
Q	P1	2 kW
S	P2	0 kW
PF	P3	0 kW

Voltages:

U/l/f		
U	U12	407 V
I	U23	398 V
f	U13	400 V

State and circuit breaker control:

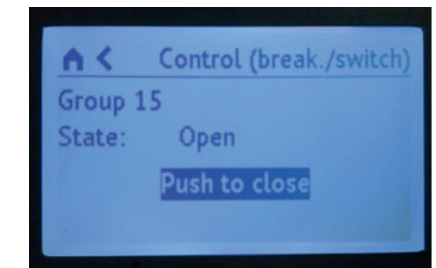

Currents:

U/l/f		
U	I1	22 A
I	I2	18 A
f	I3	20 A

## WIRING

- 12 VDC power supply created by the CX<sup>3</sup> EMS bus via communication rail or cable. **(1)**
- Connection to the CX<sup>3</sup> EMS bus via communication rail or cable. **(1)**
- The USB port on the front **(2)** is used to connect a PC in order to configure the CX<sup>3</sup> EMS modules.



### ■ CX<sup>3</sup> EMS bus:

There are 2 possible solutions for connection to the bus:



At the back of the modules via communication rail  
Cat.Nos 4 149 01/02/03

At the bottom of the modules via communication cables  
Cat.Nos 4 149 07/08/09



The CX<sup>3</sup> EMS bus connection specifications are common to all CX<sup>3</sup> EMS products and are detailed in the product data sheets.



The use of the configuration software is described in the “CX<sup>3</sup> EMS configuration software” section (see page 80).



### SETTING PARAMETERS

Various parameters can be set on the EMS CX<sup>3</sup> mini-configurator, such as:

- Settings: date, time, password, contrast, backlighting, selector address, language, definition of home page.
- Option of renaming groups
- Module-specific settings

For example, changing the current direction for measurement:

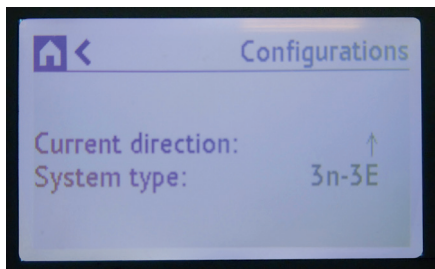

For example, changing the type of circuit for measurement:

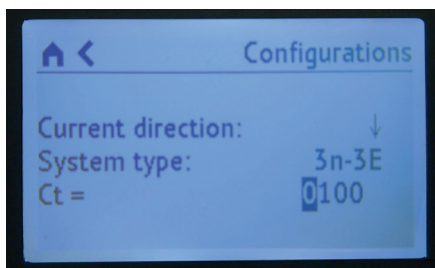

### ADDRESSING

Addressing can be done:

- Locally on the product
  - addressing from 1 to 9 using a “virtual selector” from the mini-configurator screen.
- Via software
  - addressing from 1 to 247
  - the “virtual selector” then stays on 0.

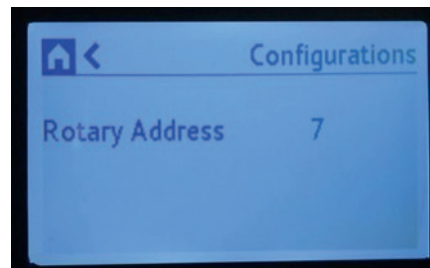

**i** The CX<sup>3</sup> EMS bus connection specifications are common to all CX<sup>3</sup> EMS products and are detailed in the product data sheets.

**!** Local setting using the selector takes priority over software Setting parameters. In the event of malfunction, check that the selector is definitely on zero.

**i** Modifications such as:  
-group name  
-sense of current  
-type of system ...  
can be done either on the mini-configurator or via the EMS configurator software. It will be automatically transferred to the second device.





# CX<sup>3</sup> EMS CONFIGURATION SOFTWARE

## Product specifications

The CX<sup>3</sup> EMS configuration software can be downloaded free of charge from the online catalogue.

It can be used to configure, address and test the CX<sup>3</sup> EMS system in your installation.

It also contains a free 30-day trial of the Energy Management software. Thereafter, licence key Cat. Nos 4 149 38/4 149 39 needs to be used.

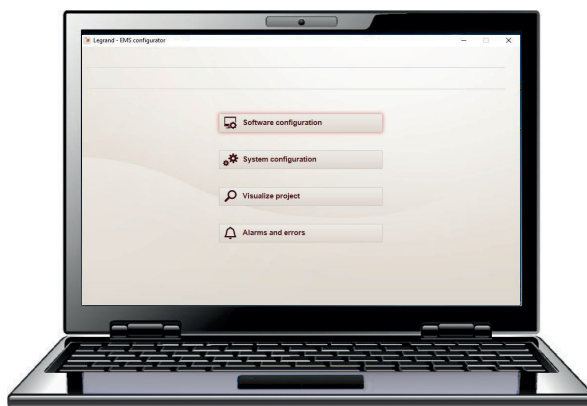

### CHARACTERISTICS

- Display and use on a computer.
- Transfers configurations to the CX<sup>3</sup> EMS system by means of a physical connection to interface 4 149 40 or mini-configurator 4 149 36, via a B type USB/micro USB cable.



Using CX<sup>3</sup> EMS modules in an installation as well as the configuration of the Energy Management Web Servers (Cat.No 4 149 47/48/49) allow sending emails, alert notifications, reports or events on a multiple of media: PC, smartphone, tablet ... You can find the tutorials concerning the configuration on [www.legrand.com/ecatalogue](http://www.legrand.com/ecatalogue).

### SETTING PARAMETERS

The CX<sup>3</sup> EMS configuration software can easily be downloaded from the online catalogue. The software icon then appears on the computer desktop.

We do however recommend using a laptop computer, to make it easier to transfer data to the CX<sup>3</sup> EMS system in the enclosure.

**i** When the PC is connected for the first time to the CX<sup>3</sup> EMS system, the drivers are installed automatically.

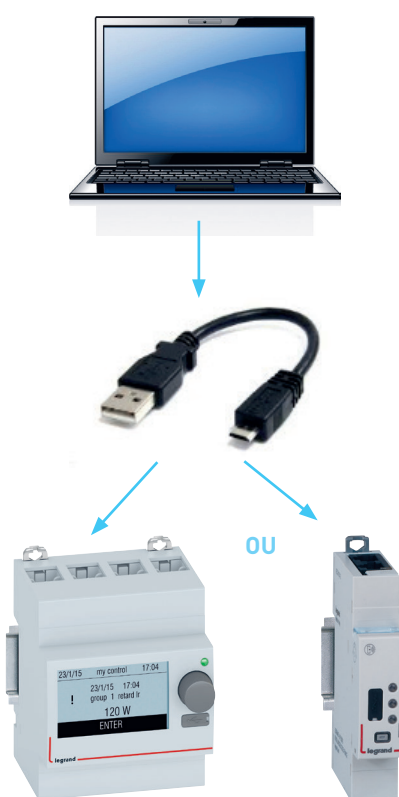

### PRODUCT SELECTION

The CX<sup>3</sup> EMS configuration software can be used for the following operations:

- addressing of modules,
- accessing some specific settings linked to the modules,
- installation test,
- alarm display,
- project preview,
- import/export a project.

**i** A complete project configuration which has already been created can be exported so it can be reused later exactly as it is, or modified for use in different project.

## MENUS OVERVIEW

### ■ « Home » menu:

The display takes the form of 4 menus providing access to various sub-menus.

Access to software settings such as: version, language, communication port.

Access to the project preview as it will appear for the end user.

Access to CX<sup>3</sup> EMS module firmware update procedure.

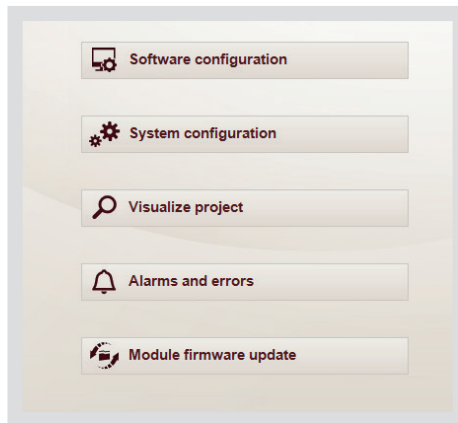

Access to the system settings.

Access to the alarms and errors lists in the configuration.

### ■ « Configure the system » menu:

View and modify the system when the PC is directly connected to the system via the USB cable.

Access to the settings of the «link» functions.

Import a configuration which was previously created.

Save a configuration in XML format directly to your computer.

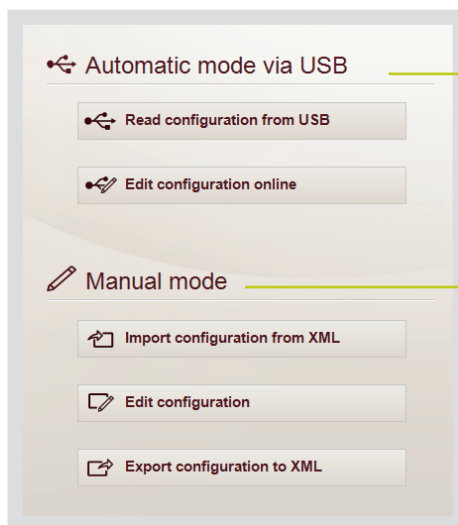

PC connected to the system.

Start configuring the system.

PC not connected to the system.

Start configuring the system.

■ « Read configuration via USB » menu:

Automatic addressing of CX<sup>3</sup> EMS modules or local addressing via the selector

Access to detailed help on addressing, the group concept, etc.

Found: 9 modules 6 groups

Press "Continue" to import structure ignoring faulty modules or press "Refresh" to retry.

Import errors				
Model	Module ID	Address		Result
4 149 40	EMS/RS485 interface	0000-0000-007E-1257	10	✓
4 149 29	State (modular device)	0000-0000-008D-6E73	11	✓
4 149 32	Control (motor driven )	0000-0000-000B-0272	15	✓
4 149 30	State (contact+fault)	0000-0000-000B-027F	14	✓
4 149 31	Control + State (CT/LR)	FFFF-FFFF-FFFF-FC9F	13	✓
4 149 26	Measure (pulse)	0000-0000-000B-02A9	12	✓
4 149 30	State (contact+fault)	0000-0000-0059-62E3	15	✓
4 149 20	Measure (threephase 63A)	FFFF-FFFF-FFFF-FD11	11	✓
4 149 23	Measure (CT)	FFFF-FFFF-FFFF-FD32	15	✓
4 149 36/37	EMS disolav	0000-0000-008D-6E53	17	✓

Software ad Refresh Continue

legrand

For each CX<sup>3</sup> EMS module found: the catalogue number, the type, the module ID and address are «read» by the software and displayed in this table.

Automatically displays the number of modules and groups composing the CX<sup>3</sup> EMS system.

Used to start automatic addressing by the software.

Update data displayed on the PC screen. After a change, error corrected.

Access to the rest of the configuration, "Edit online configuration".

Display any faults on the CX<sup>3</sup> EMS system.

■ «Read configuration via USB » menu (continued):

The configuration switches of the universal control and signaling modules, Cat.No 4 149 30 and 4 149 32, can be left in the factory configuration on 0 position. In this case, the configuration of these 2 modules is carried out via the EMS configuration software.

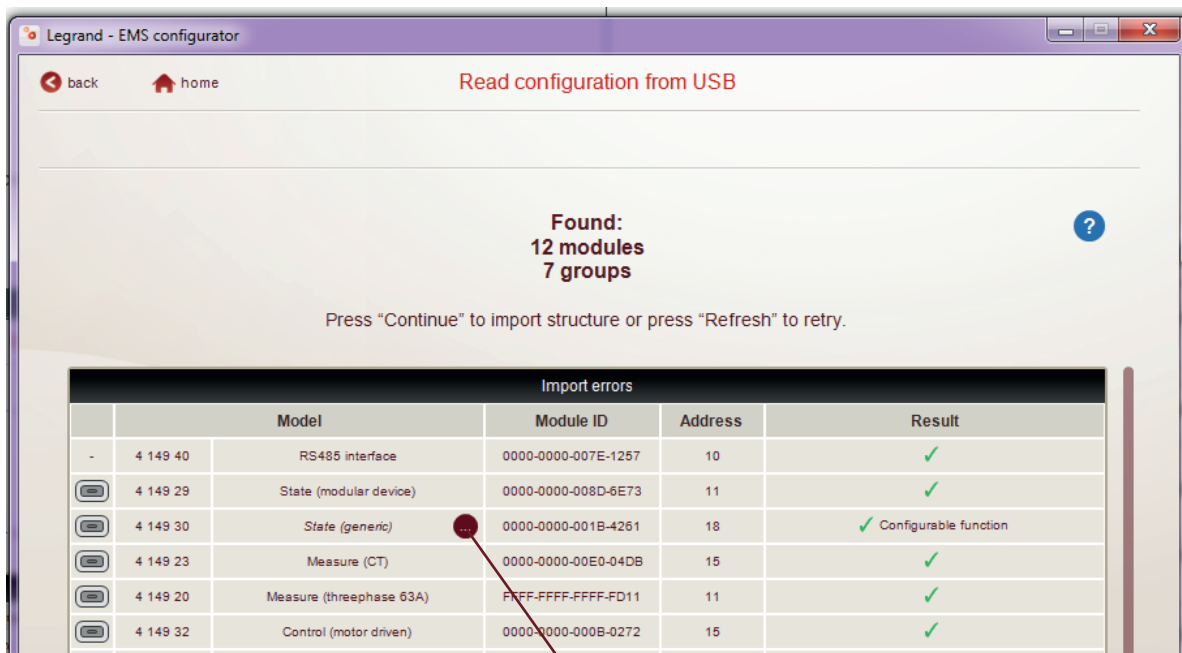

If the switches are in position «0», this icon appears on the relevant module. Simply click on it to access the switch settings on the PC.

Select the configuration chosen for the module, to validate, click on «ok».

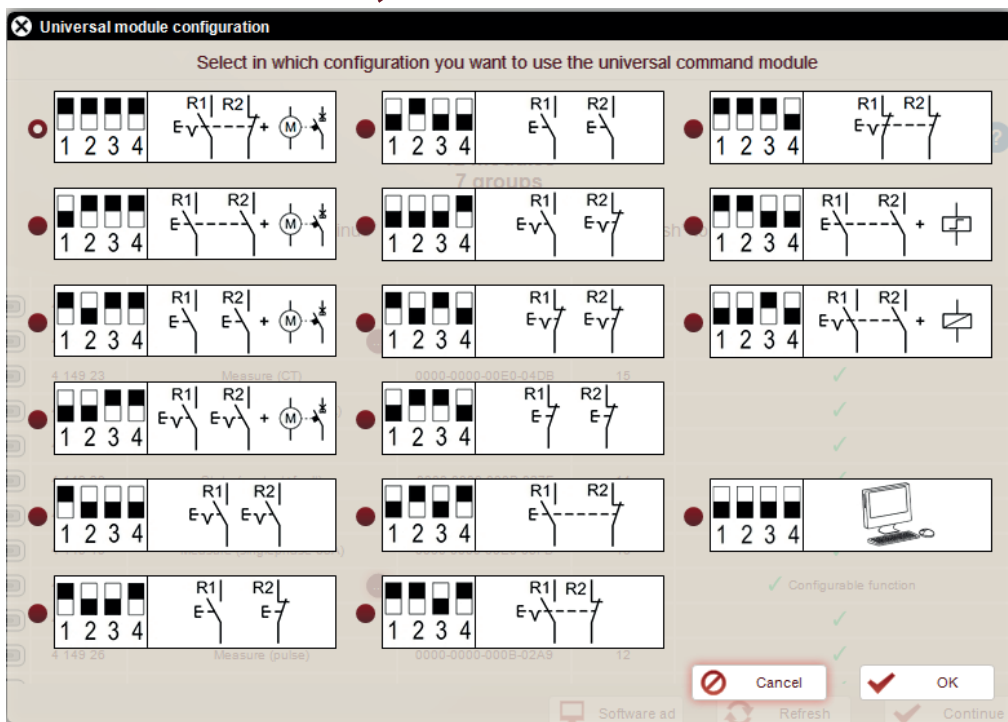

■ « Edit online configuration » menu, page « Module groups »

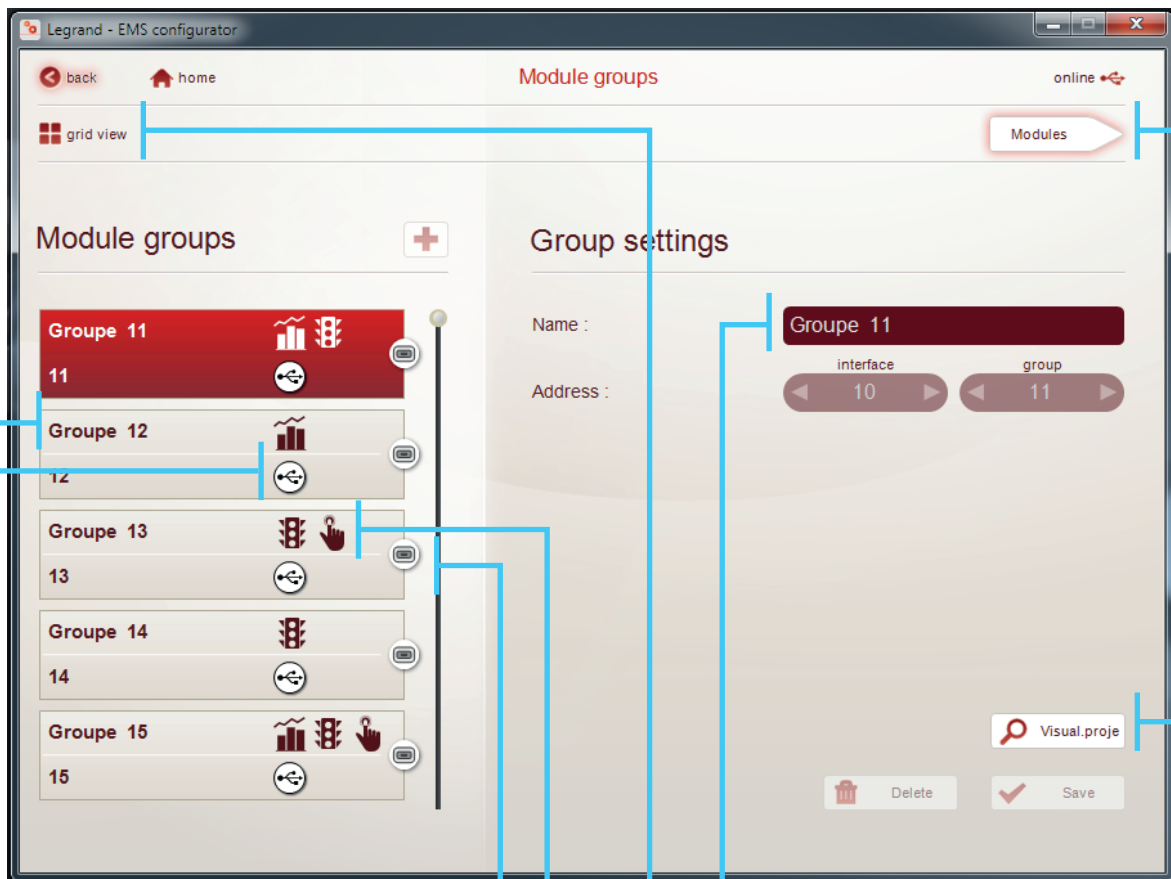



Error detection.

Quick identification of CX<sup>3</sup> EMS module(s): By pressing this icon, the relevant EMS module(s) will blink.

Display the groups composing on the CX<sup>3</sup> EMS system.

Display of icons identifying the functions accessible in the group.

-  = Measurement module
-  = State reporting module
-  = Control module

The name of the group can be changed.

Direct access to the project preview as it appears to the end user.

Access to the modules belonging to the selected group.

Other possible view :  
Thumbnail view of the different groups of the CX<sup>3</sup> EMS system.

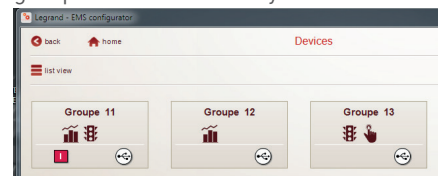



■ « Edit online configuration » menu, page « Modules »

Example of an advanced setting page for a motorised control.

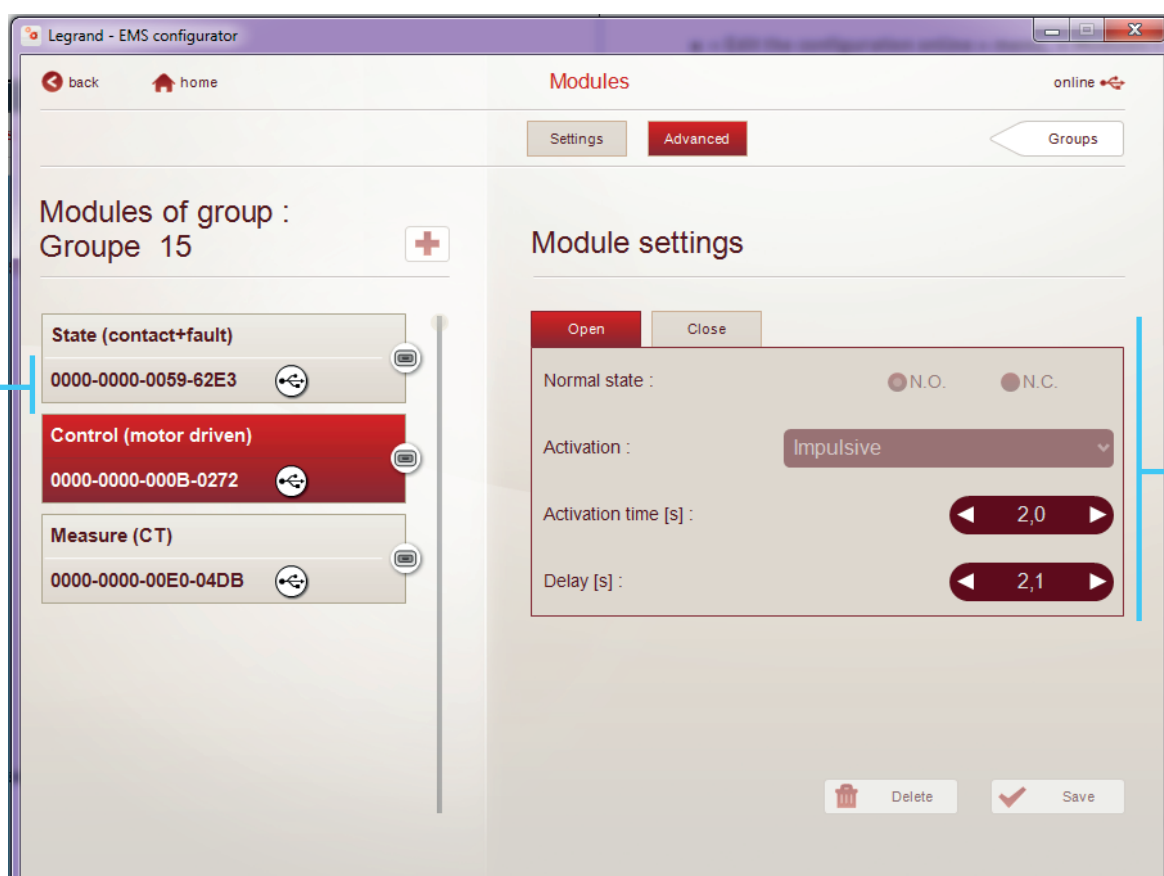

Module ID  
Unique number

Possible settings parameters for this type of CX<sup>3</sup> EMS module, accessible only via the software:

- Normal contact type: normally open or normally closed.
- Type of contact activation: impulse, maintained.
- Activation time: adjustable time delay.
- Duration of the activation delay: adjustable delay time.
- ....

■ « Edit online configuration » menu, page « Modules » (continued)

All the measurement modules are configurable via the configuration software.  
 Example of an advanced configuration page for a three-phase measurement module.

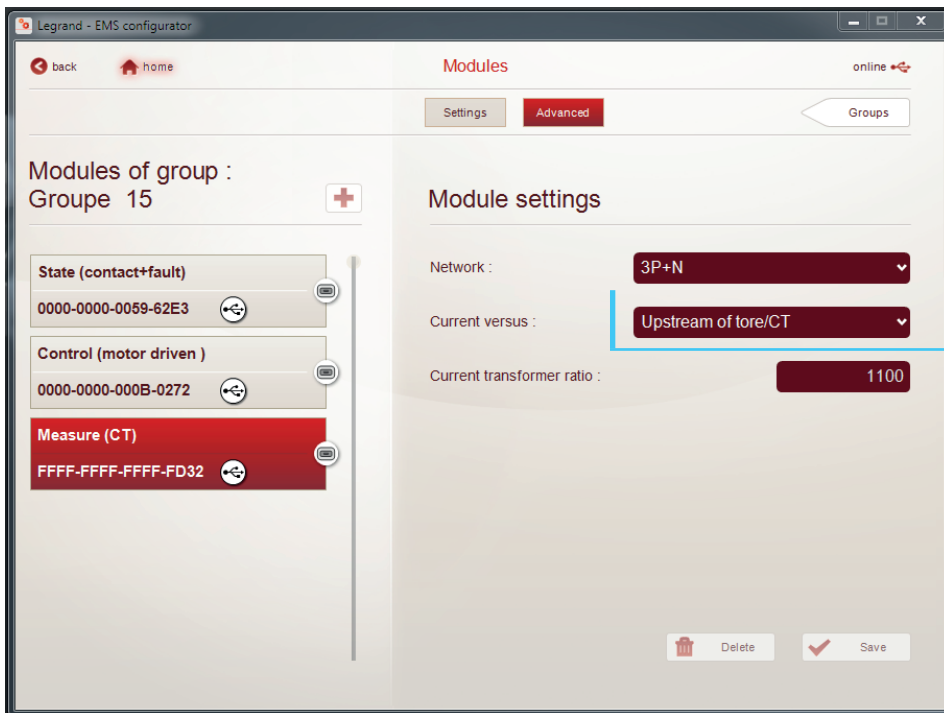

Possible settings for this type of CX<sup>3</sup> EMS module:

- Type of network.
- Current direction in the coil / CT.

A measurement module Cat.No 4 149 19/20 or 23 associated with a universal control module Cat.No 4 149 32 allows the use of the load shedding / rebalancing function. However, the configuration switches of the measurement module must be set to «0».

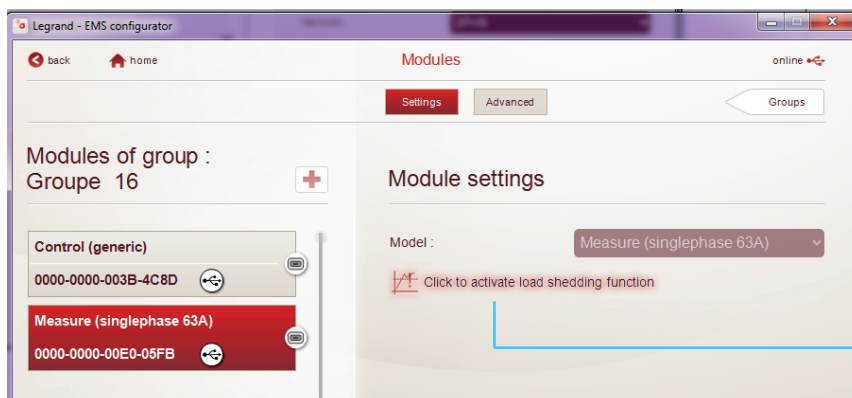

Select the load-shedding function

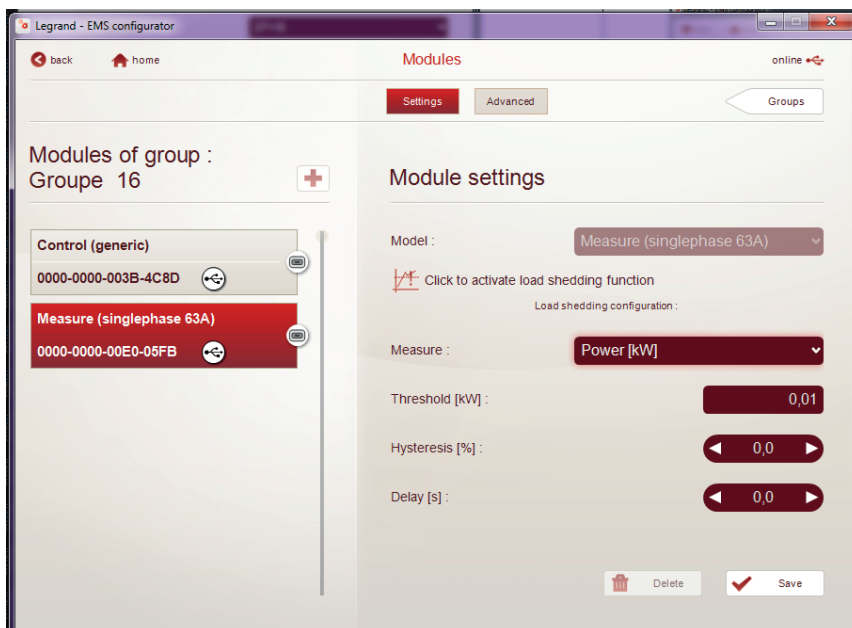



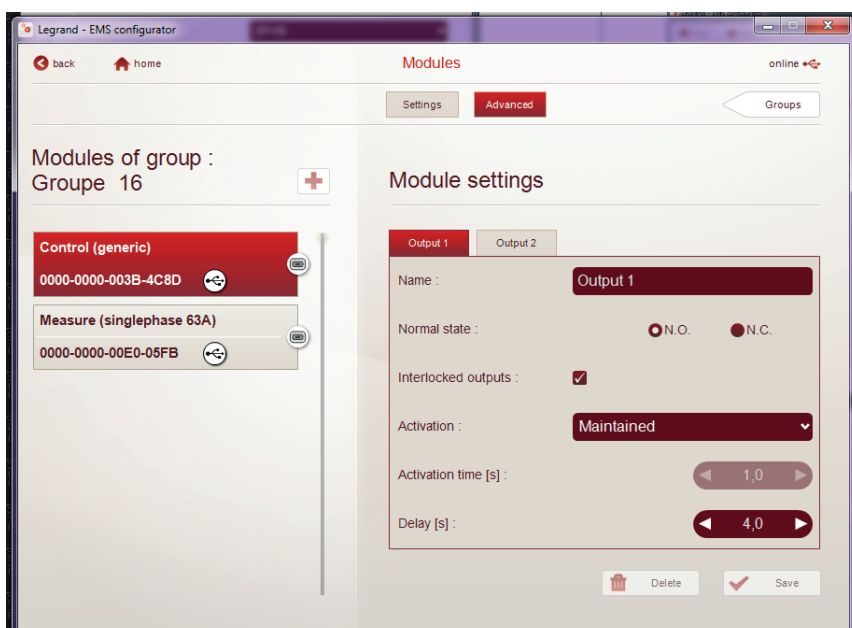







Adjust the parameters associated with the load-shedding function.



Complete the setting of the load-shedding function using the advanced parameters of the universal control module.

■ « Link function » menu

The «link» function allows you to create automatic actions by linking 2 CX<sup>3</sup> EMS modules from 2 different groups. You just need to associate a module generating the event with a module generating the action. Below is a list of possible combinations:

Modules generating the event	Modules generating the action																										
	Control	Control + state reporting	State reporting																								
<p>Measurement</p>  <p>Single-phase measurement module Cat.No 4 149 19</p> <p>Three-phase measurement module Cat.No 4 149 20</p>			  Only with the module configured (locally or remotely) as shown: <table border="1" data-bbox="1284 1310 1484 1355"> <tr> <td><input type="checkbox"/></td> <td><input type="checkbox"/></td> <td><input type="checkbox"/></td> <td><input type="checkbox"/></td> <td>X1</td> <td>*</td> </tr> <tr> <td><input type="checkbox"/></td> <td><input type="checkbox"/></td> <td><input type="checkbox"/></td> <td><input type="checkbox"/></td> <td>X2</td> <td>*</td> </tr> <tr> <td><input type="checkbox"/></td> <td><input type="checkbox"/></td> <td><input type="checkbox"/></td> <td><input type="checkbox"/></td> <td>X3</td> <td>*</td> </tr> <tr> <td>1</td> <td>2</td> <td>3</td> <td>4</td> <td></td> <td></td> </tr> </table>	<input type="checkbox"/>	<input type="checkbox"/>	<input type="checkbox"/>	<input type="checkbox"/>	X1	*	<input type="checkbox"/>	<input type="checkbox"/>	<input type="checkbox"/>	<input type="checkbox"/>	X2	*	<input type="checkbox"/>	<input type="checkbox"/>	<input type="checkbox"/>	<input type="checkbox"/>	X3	*	1	2	3	4		
<input type="checkbox"/>	<input type="checkbox"/>	<input type="checkbox"/>	<input type="checkbox"/>	X1	*																						
<input type="checkbox"/>	<input type="checkbox"/>	<input type="checkbox"/>	<input type="checkbox"/>	X2	*																						
<input type="checkbox"/>	<input type="checkbox"/>	<input type="checkbox"/>	<input type="checkbox"/>	X3	*																						
1	2	3	4																								
<p>State reporting</p>  <p>AC + FS signalling auxiliary module Cat.No 4 149 29</p> <p>Universal signalling module 3 LEDs Cat.No 4 149 30</p>			<p><b>Module in duplicate mode (1)</b></p>																								
<p>Control + state reporting</p>  <p>Control and state reporting module Cat.No 4 149 31</p>			<p><b>Module in duplicate mode (1)</b></p>																								

(1) This configuration is standard using the universal signaling module in slave mode (duplicate function).

 The «link» function allows you to associate only one event to an action.

 Modules can only associate on a single link function.

■ « Link function » menu (continued)

 The Setting parameters of the link function is detailed in the Installation Manual of the CX<sup>3</sup> EMS Configuration Software, which can be downloaded from [www.legrand.com/ecatalogue](http://www.legrand.com/ecatalogue)

 If the link function does not appear on your software, please download the latest version of CX<sup>3</sup> EMS configuration software from [www.legrand.com/ecatalogue](http://www.legrand.com/ecatalogue)

 The link function is only possible since the 2nd half of 2018, an update of the modules is possible for older products. Details in the section «menu» firmware update of the modules».

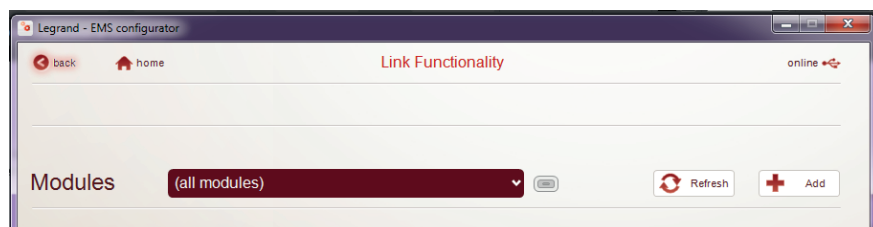

Select «Add» to set up a new link function.

■ « Link function » menu (continued)

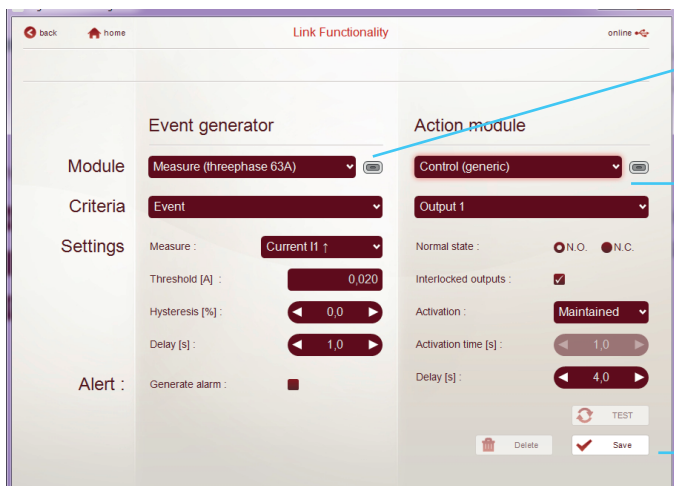

Choose the module that should generate the action, then its associated parameters.

Choose the module that should execute the action, then its associated parameters.

Then, save.



All Linked functions are listed on this page.

Add a function.

Modify an existing function.

Delete an existing function.

**i** The setting of the link function is detailed in the Installation Manual of the CX<sup>3</sup> EMS configuration software downloadable from [www.legrand.com/ecatalogue](http://www.legrand.com/ecatalogue)

■ « Link function » menu (continued)

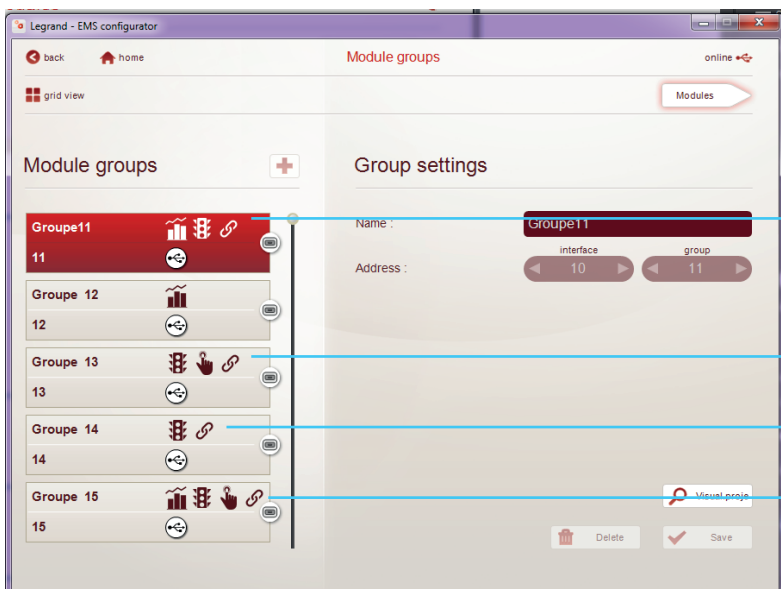





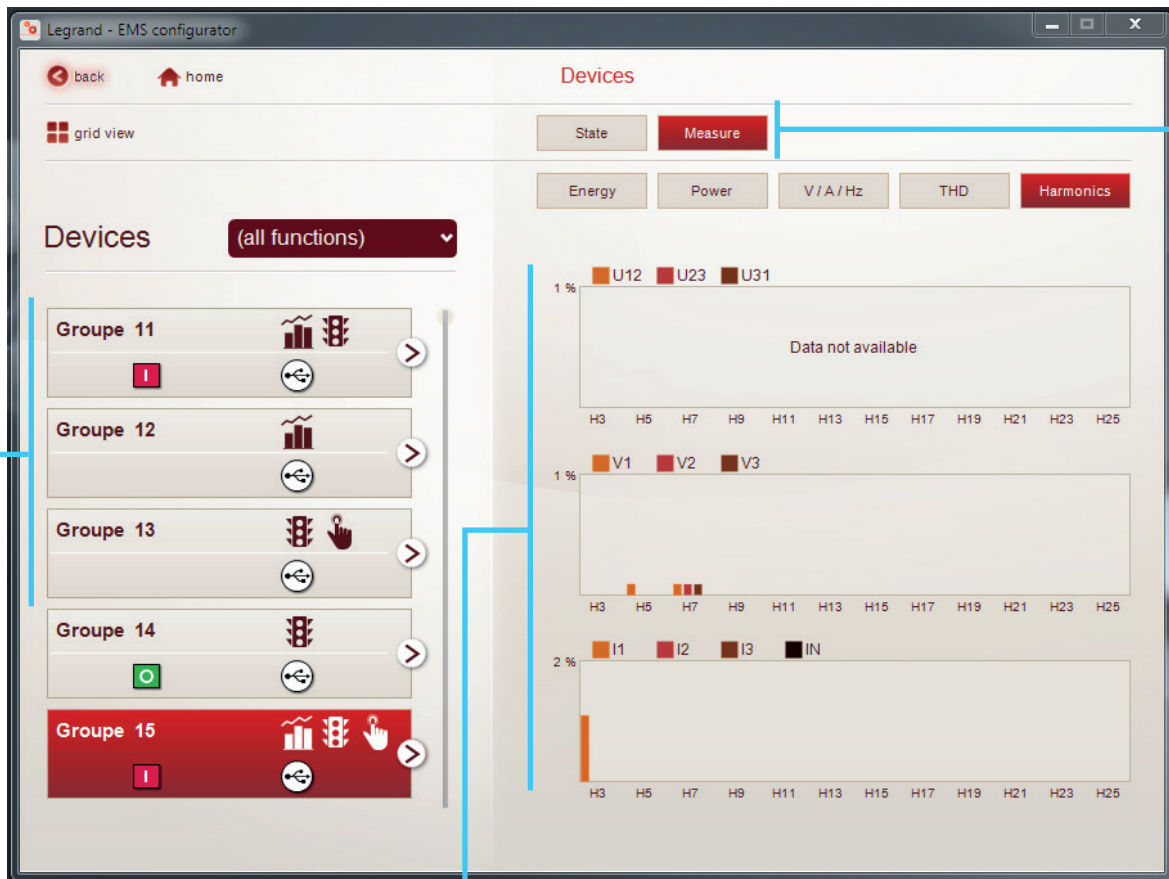

Once the linked functions are created, the relevant modules are identified by this symbol.

■ « View project » « view measurement » menu

Used to have a project preview identical to the one of the end user.



Display the status of each group and the icons of the associated functions:

- ON / OFF / FLT status   
- Functions: measurement  ,  
view, control ...  
- Connection fault 
- ...

Example of displaying "measurement" data, in this case harmonics.

Access to the data to be displayed.







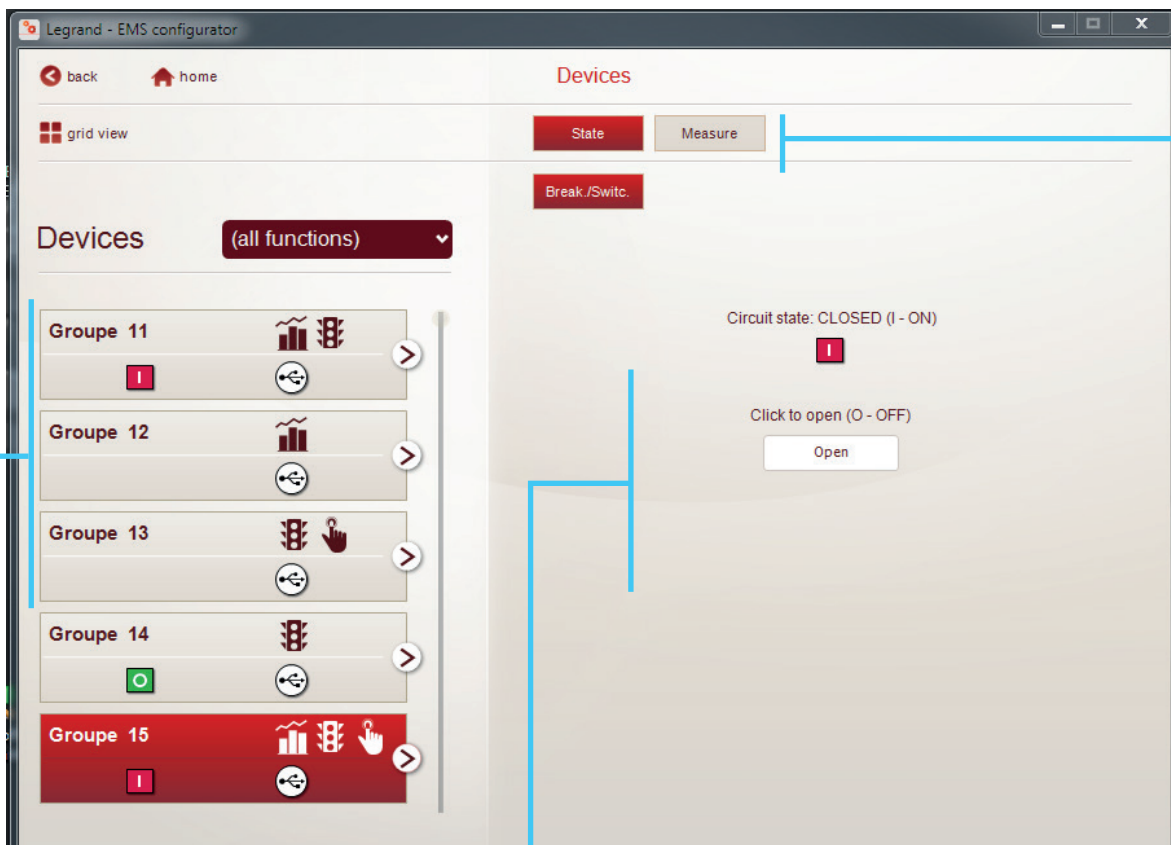



■ « View project » « view status» menu

Used to have a project preview identical to the one of the Energy Web Server.



Display the status of each group and the icons of the associated functions:

- ON / OFF / FLT status   
- Functions: measurement  ,  
view, control ...  
- Connection fault 
- Connection OK 
- ...

View group status and access control.

Access to the data to be displayed.

■ « Module firmware update » menu

Updating the modules is done simply via the CX<sup>3</sup> EMS configuration software. You can access it through the link on the software's homepage.

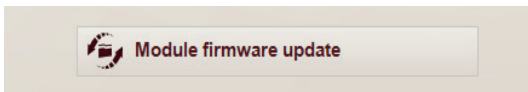

Just let the instructions on the screen guide you:

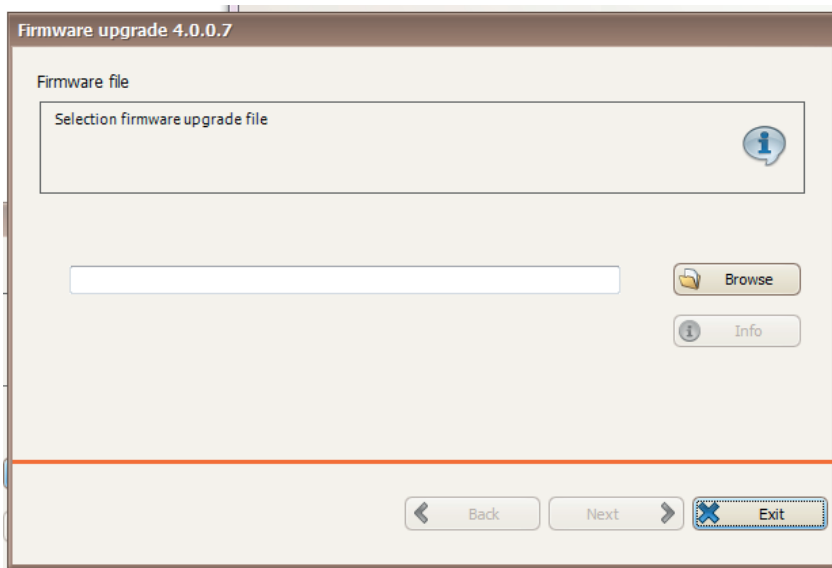



 The procedure for updating the modules is detailed in the CX<sup>3</sup> EMS Configuration Software Installation Manual, which can be downloaded from [www.legrand.com/ecatalogue](http://www.legrand.com/ecatalogue)

 Module updates are downloaded and saved to your PC automatically when downloading the new version of EMS configurator.

## ■ « Module firmware update » menu (continued)

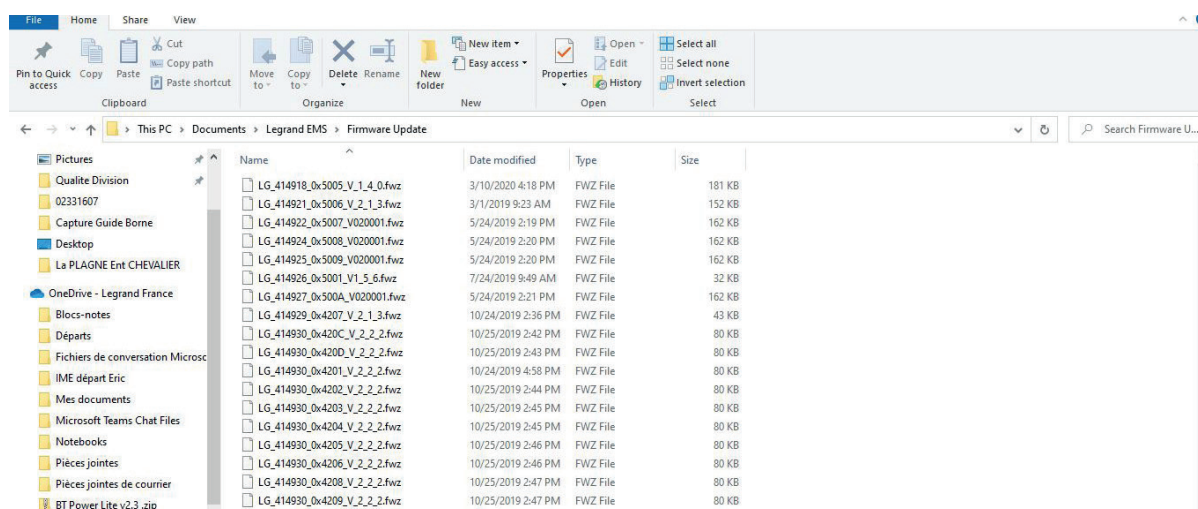
An update is available for each CX<sup>3</sup> EMS module catalogue number:



 If the link function does not appear on your software, please download the latest version of CX<sup>3</sup> EMS configuration software from [www.legrand.com/ecatalogue](http://www.legrand.com/ecatalogue)

 The link function is only possible since the 2nd half of 2018, an update of the modules is possible for older products. Details in the section «menu/module firmware update».

### ■ « Errors and alarms » menu

The CX<sup>3</sup> EMS system memorise the last 20 errors and alarms which have appeared during configuration.

The table indicates the date, time, group name, address and type of error or alarm.

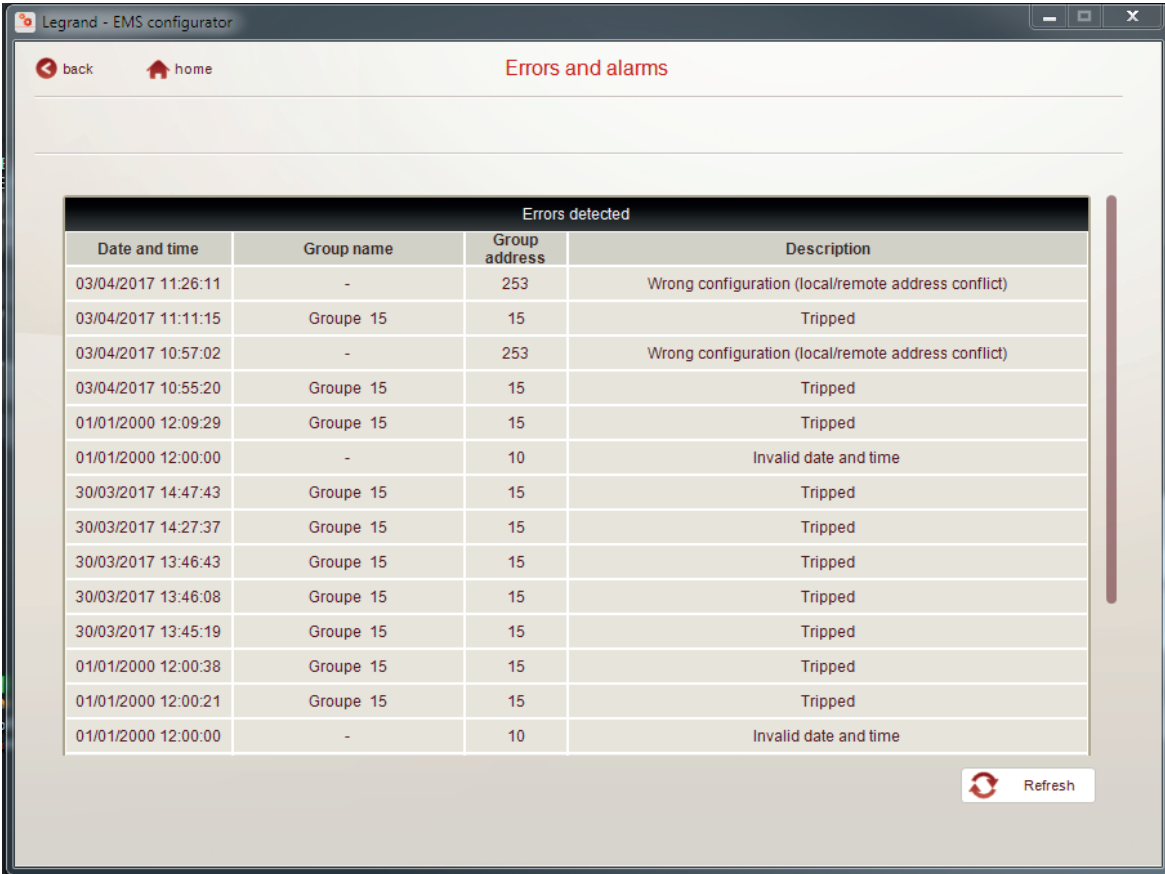

Errors detected			
Date and time	Group name	Group address	Description
03/04/2017 11:26:11	-	253	Wrong configuration (local/remote address conflict)
03/04/2017 11:11:15	Groupe 15	15	Tripped
03/04/2017 10:57:02	-	253	Wrong configuration (local/remote address conflict)
03/04/2017 10:55:20	Groupe 15	15	Tripped
01/01/2000 12:09:29	Groupe 15	15	Tripped
01/01/2000 12:00:00	-	10	Invalid date and time
30/03/2017 14:47:43	Groupe 15	15	Tripped
30/03/2017 14:27:37	Groupe 15	15	Tripped
30/03/2017 13:46:43	Groupe 15	15	Tripped
30/03/2017 13:46:08	Groupe 15	15	Tripped
30/03/2017 13:45:19	Groupe 15	15	Tripped
01/01/2000 12:00:38	Groupe 15	15	Tripped
01/01/2000 12:00:21	Groupe 15	15	Tripped
01/01/2000 12:00:00	-	10	Invalid date and time













## FOLLOW US ALSO ON

- @ legrand.com
-  youtube.com/user/legrand
-  facebook.com/Legrand
-  twitter.com/Legrand
-  pinterest.com/legrandgroup
-  instagram.com/legrandnews



**Head office**  
and International Department  
87045 Limoges Cedex - France  
Tel: + 33 (0) 5 55 06 87 87  
Fax: + 33 (0) 5 55 06 74 55